



**GENC**<sup>®</sup>  
DEKORATİF ISI YALITIM

**2024**

**ÜRÜN KATALOĐU**

Product Catalogue

## Hakkımızda

Firmamız, Her açıdan olabildiğince fonksiyonel ve çok geniş kullanım alanına sahip ürünlerle hizmeti hedeflemektedir.

Ürettiğimiz ürünlerin temel işlevi yalıttır.güvenli yapıların oluşmasında ürün yelpazemiz ile katkıda bulunmaktayız. Firmamız toplumsal sorumluluk bilinci ile sağlıklı yaşam ortamı oluşturma misyonunu desteklemektedir.

Binalarda yalıtım sistemleri son yıllarda önem kazanmıştır.artan talebin karşılanması için Genç Dekoratif Isı Yalıtım olarak hızlı hizmet ile doğru ve güvenilir ürünler sunarak ,hizmet sonrası müşteri memnuniyetini sağlamak amaçlarımız arasındadır.

## About us

Our company aims to serve and provide all kinds of products that are very functional and have a wide range of uses.

The main function of the products we produce is insulation. We contribute with our product range in the formation of safe structures. Our company supports the mission of creating a healthy living environment with a sense of social responsibility.

Insulation systems in buildings have gained importance in recent years. In order to meet the increasing demand, as Genc Dekoratif Isı Yalıtım, our aim is to provide customer service by providing fast , accurate and reliable products.

## Dış Cephe Ürünler

05-45

EXTERIOR PRODUCTS منتجات الديكور الخارجي

• <b>Söveler</b> (Door & Window Frame) .....	05
• <b>Taçlar</b> (Crowns) .....	11
• <b>Desenli Taç</b> (Patterned Crowns) .....	14
• <b>Denizlikler</b> (Window Sills) .....	17
• <b>Kat Silmesi</b> (Floor Stringer) .....	20
• <b>Desenli Kat Silmesi</b> (Patterned Floor Stringer) .....	23
• <b>Dekor Profil</b> (Decorative Profile) .....	24
• <b>Dekoratif Kaplama</b> (Decorative Coating) .....	26
• <b>Taç Dekor Ürünleri</b> (Decorative Crown Products) .....	28
• <b>Köşe Elemanı</b> (Corner Element) .....	29
• <b>Çtalar</b> (Lath) .....	31
• <b>Dekoratif Süs</b> (Decorative Ornament) .....	32
• <b>Sütunlar</b> (Pillar) .....	34
• <b>Kaideler</b> (Pedestals) .....	35
• <b>Boru Kaplama</b> (Pipe Covering) .....	37
• <b>Payandalar</b> (Buttress) .....	38
• <b>Kilit Taşları</b> (Key Stones) .....	39
• <b>Harpuşta</b> (Cover Fence) .....	40
• <b>Çember</b> (Circle) .....	40
• <b>Gizli Işık Profilleri</b> (Hidden Light Profiles) .....	41
• <b>Fuga</b> (Fair Coating) .....	43
• <b>Yalı Baskı</b> (Brick Print) .....	44
• <b>EPS Ambalaj Ürünleri</b> (Eps Packaging Products) .....	45

## İç Cephe Ürünler

47-52

INTERIOR PRODUCTS منتجات الديكور الداخلي

• <b>Lamba Göbekleri</b> (Rosette) .....	47
• <b>Xps Kartonpiyer</b> (Xps Coving Models) .....	48
• <b>Perde Takviyeleri</b> (Curtain Reinforcements) .....	50
• <b>Eps Asmolen</b> (Eps Plates) .....	51
• <b>Yardımcı Ürünler</b> (Buttresses) .....	52

• ÇITA • PERDE TAKVİYESİ • LAMBA GÖBEKLERİ • ASMA TAVAN • TAVAN KAPLAMA • FUGA • DESEN  
• TUĞLA GÖRÜNÜMLÜ KAPLAMA • SÖVE • DENİZLİK • TAÇ - TAÇ DEKOR ÜRÜNLERİ • KAT SİLMES  
• BORU KAPLAMA PROFİLLERİ • KÖŞE ELEMANLARI • ENJEKSİYON KÖŞE ELEMAN  
• PAYANDA • KİLİTTAŞI • BALKON SÜSÜ • PENCERE ALT DEKOR • SÜTUN KAİDE • YUVARLAK PENCERE  
• EPS DESENLİ KARTONPİYER • BANYO KARTONPİYERİ • BORDÜR • BİTİŞ PROFİLİ • IŞIK BANDI • DE  
• ÇITA • PERDE TAKVİYESİ • LAMBA GÖBEKLERİ • ASMA TAVAN • TAVAN KAPLAMA • FUGA • DESEN  
• TUĞLA GÖRÜNÜMLÜ KAPLAMA • SÖVE • DENİZLİK • TAÇ - TAÇ DEKOR ÜRÜNLERİ • KAT SİLMES  
• BORU KAPLAMA PROFİLLERİ • KÖŞE ELEMANLARI • ENJEKSİYON KÖŞE ELEMAN  
• PAYANDA • KİLİTTAŞI • BALKON SÜSÜ • PENCERE ALT DEKOR • SÜTUN KAİDE • YUVARLAK PENCERE



# DIŞ CEPHE ÜRÜNLER

*exterior products*

منتجات الديكور الخارجية





SV-01



SV-02

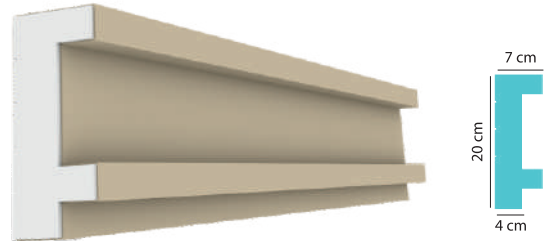

SV-03

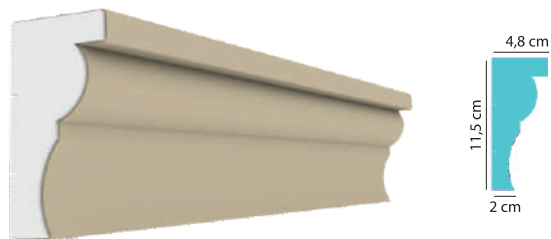

SV-04



SV-05

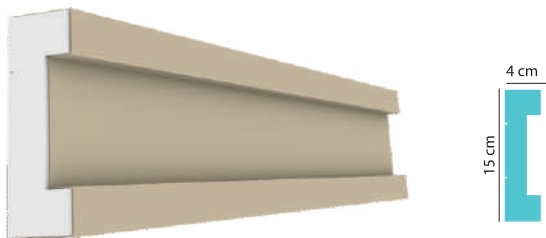

SV-06

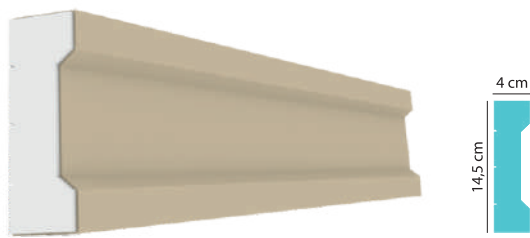

SV-07

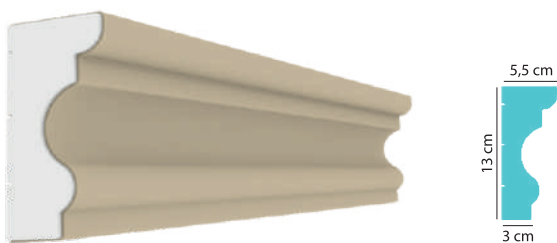

SV-08



SV-09

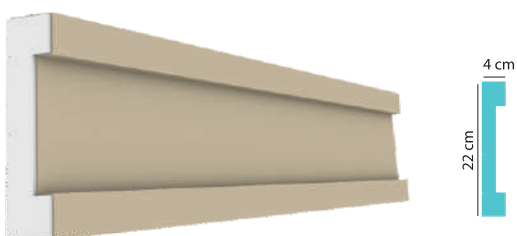

SV-10

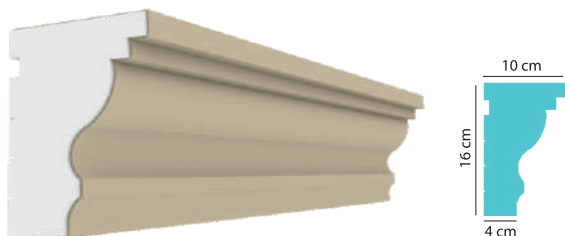

SV-11

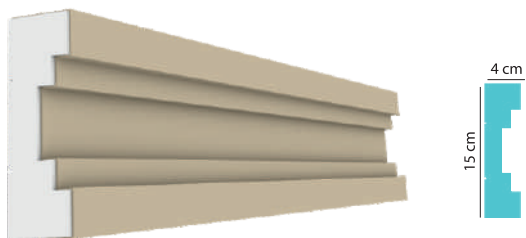

SV-12

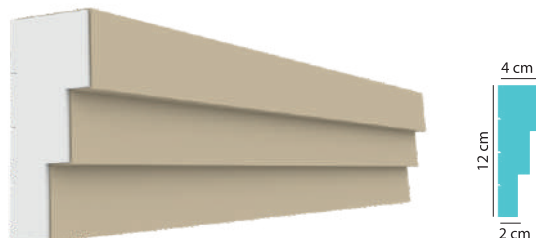

SV-13



SV-14

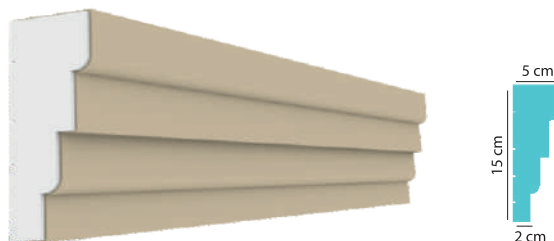

SV-15



SV-16



SV-17

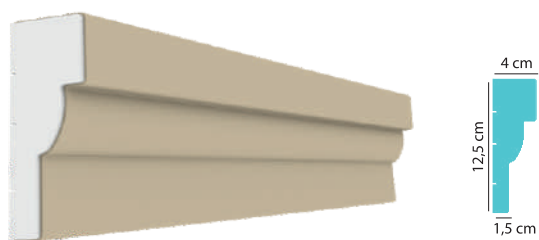

SV-18

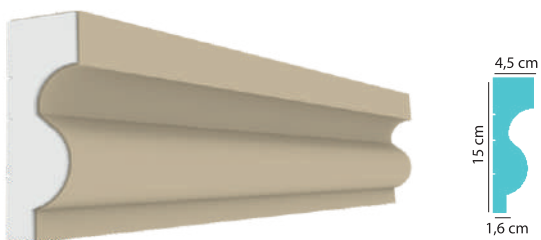

SV-19



SV-20

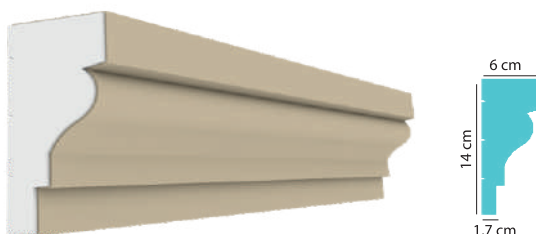

SV-21

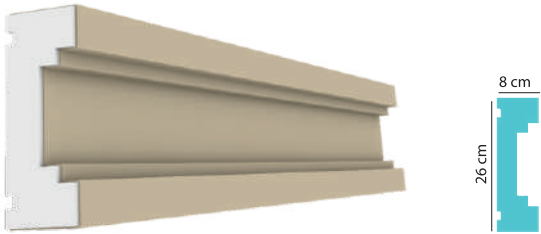

SV-22



SV-23

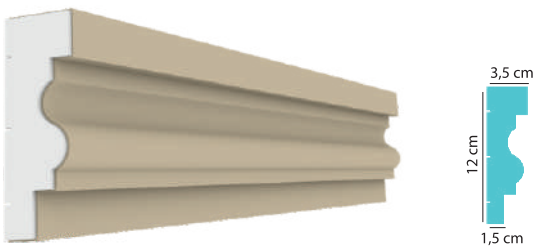

SV-24

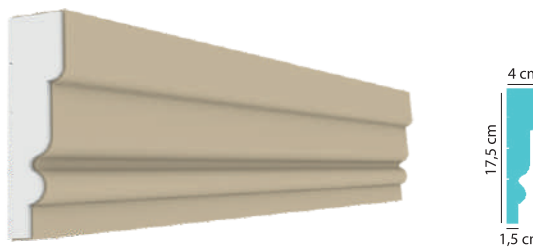

SV-25

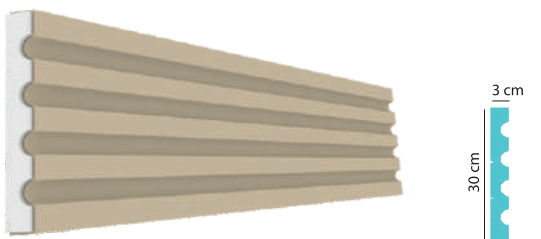

SV-26

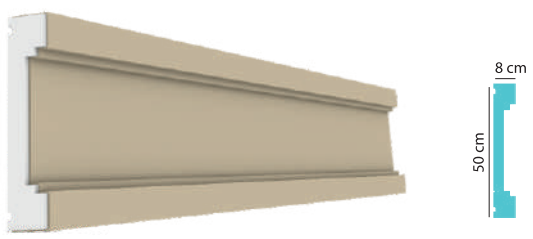

SV-27

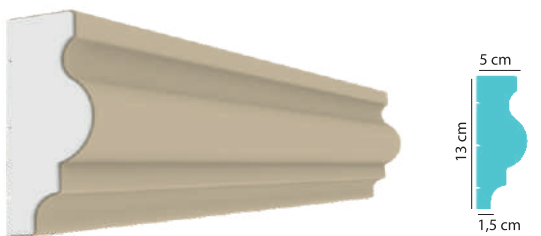

SV-28



SV-29



SV-30

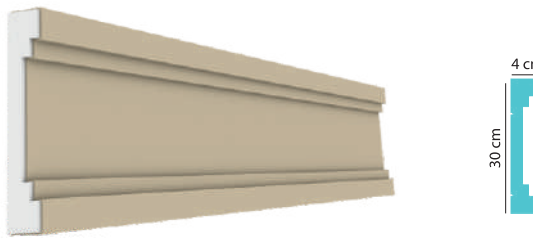

SV-31

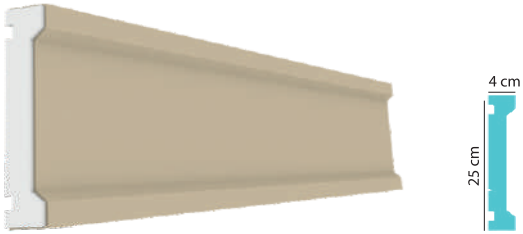

SV-32

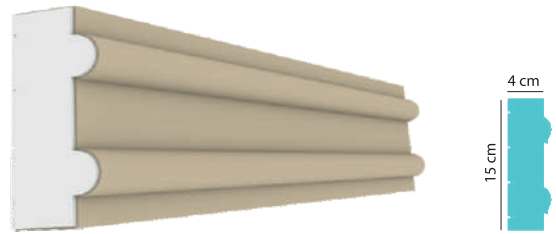

SV-33



SV-34

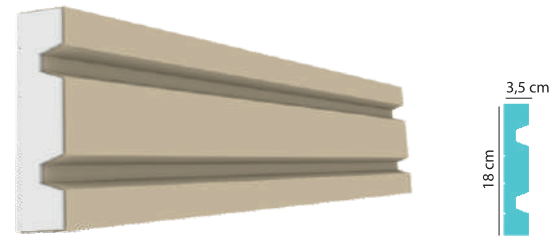

SV-35



SV-36



SV-37



SV-38



SV-39



SV-40

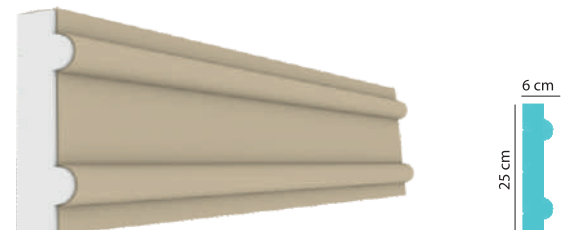



SV-41

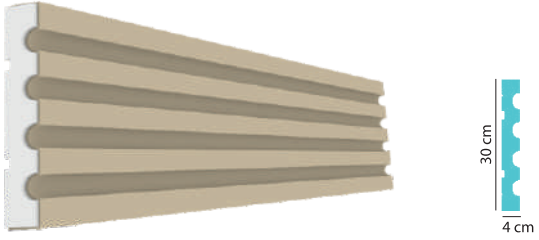

SV-42

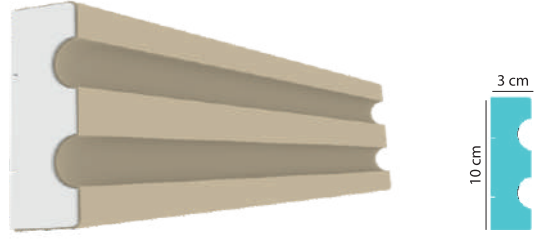

SV-43



SV-44

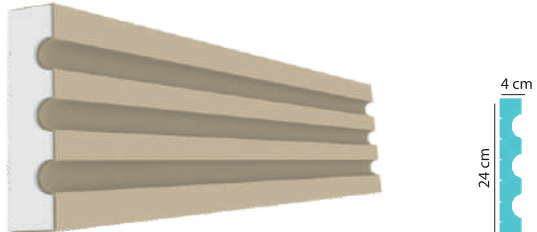

SV-45

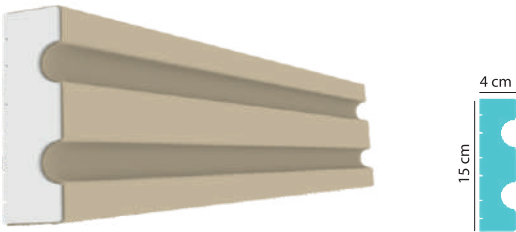

SV-46

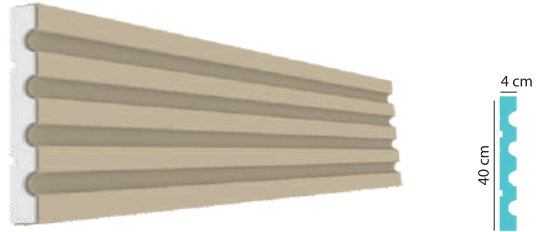

SV-47



SV-48

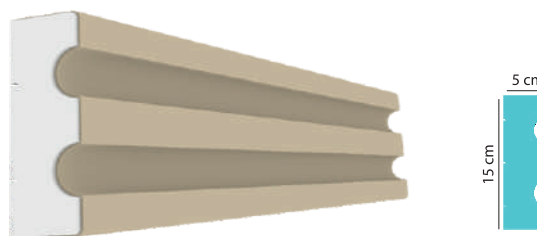

SV-49



SV-50

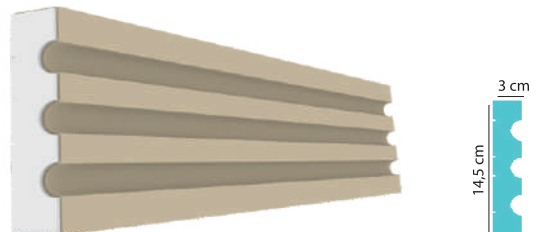

SV-51

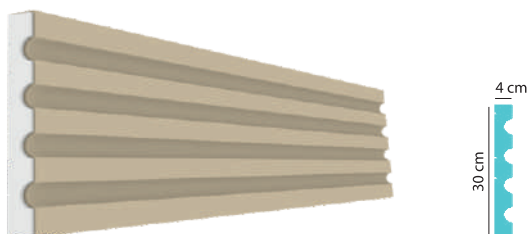

SV-52

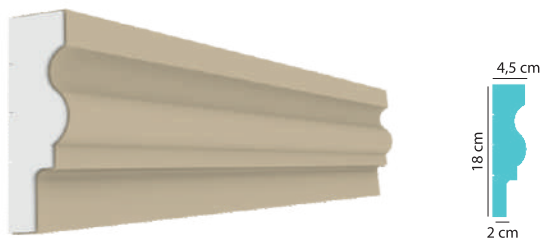

SV-53

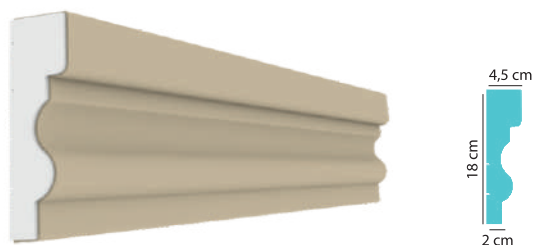

SV-54



SV-55

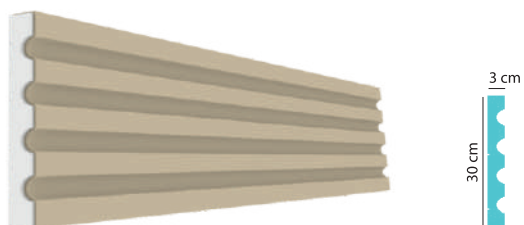

SV-56

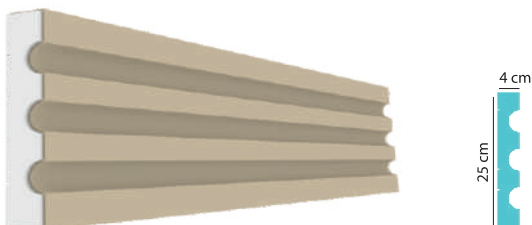

SV-57

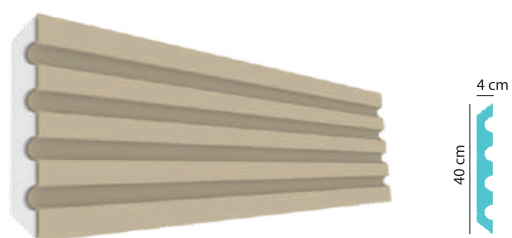

SV-58



SV-59



SV-60

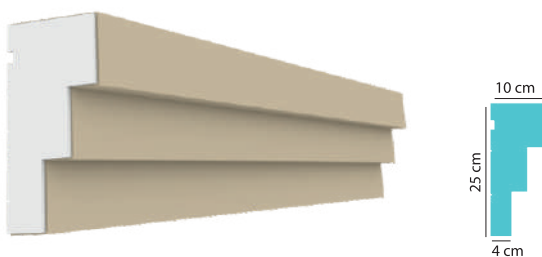

TAÇ-01



TAÇ-02



TAÇ-03



TAÇ-04



TAÇ-05

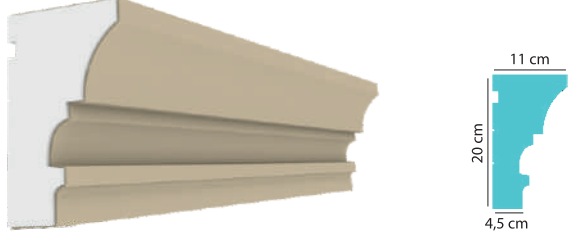

TAÇ-06



TAÇ-07



TAÇ-08



TAÇ-09

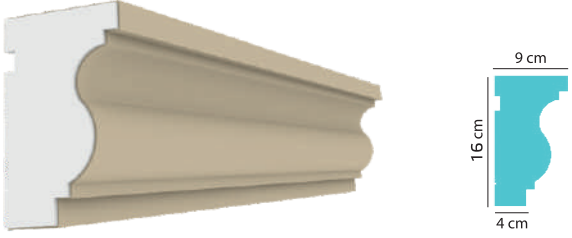

TAÇ-10



TAÇ-11

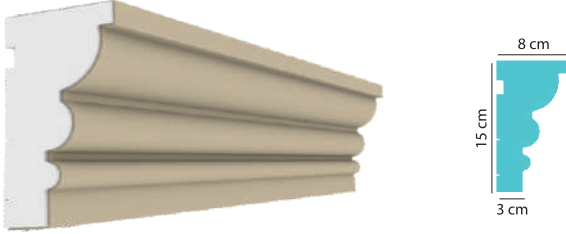

TAÇ-12

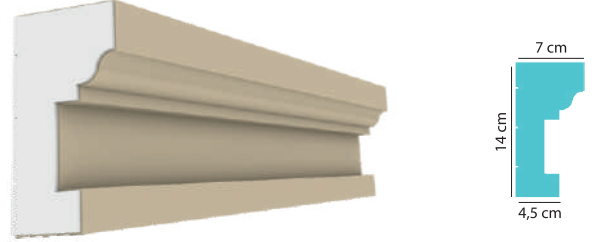

TAÇ-13



TAÇ-14



TAÇ-15



TAÇ-16



TAÇ-17



TAÇ-18



TAÇ-19



TAÇ-20





TAÇ-21

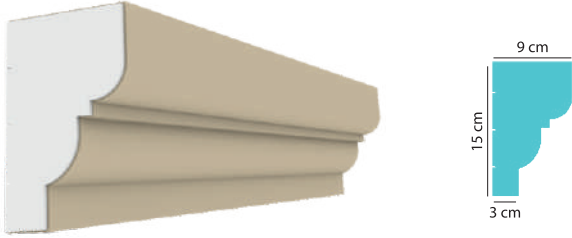

TAÇ-22

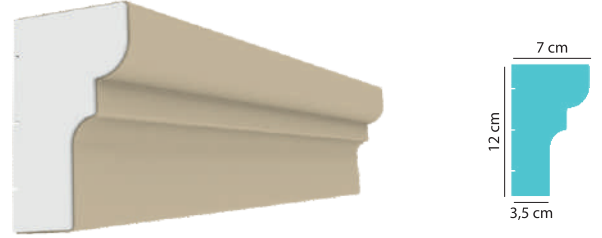

TAÇ-23

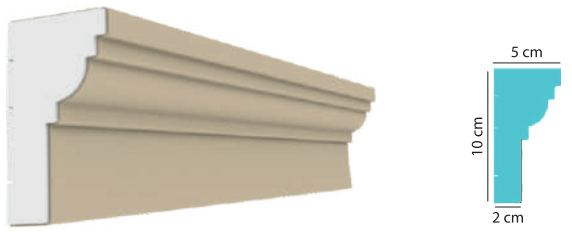

TAÇ-24



TAÇ-25



TAÇ-26

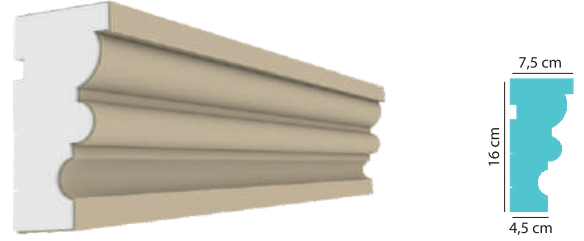

TAÇ-27



TAÇ-28



TAÇ-29



TAÇ-30



DTAÇ-01



DTAÇ-02



DTAÇ-03

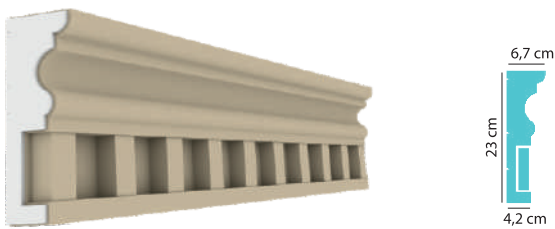

DTAÇ-04



DTAÇ-05



DTAÇ-06



DTAÇ-07

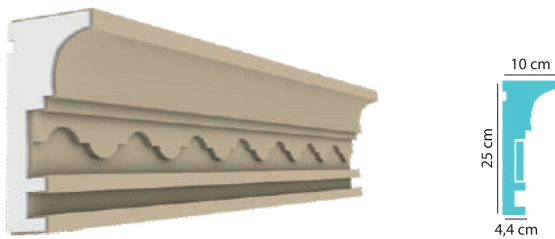

DTAÇ-08



DTAÇ-09

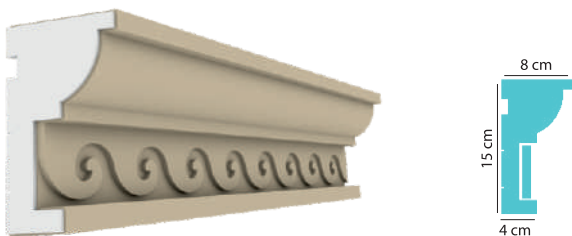

DTAÇ-10



**DTAÇ-11**



**DTAÇ-12**

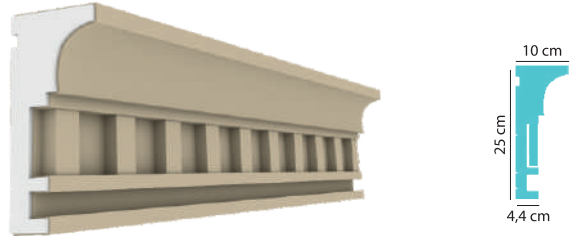

**DTAÇ-13**



**DTAÇ-14**



**DTAÇ-15**



**DTAÇ-16**



**DTAÇ-17**



**DTAÇ-18**

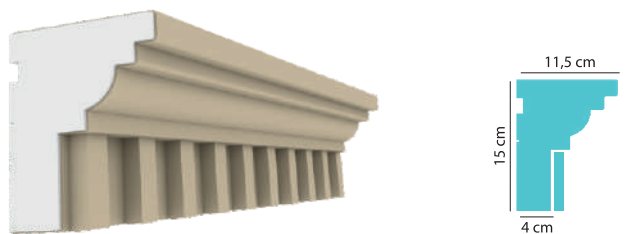

**DTAÇ-19**



**DTAÇ-20**

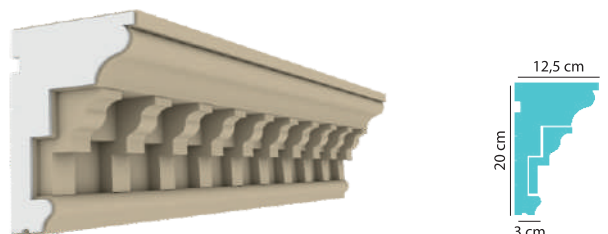

DTAÇ-21



DTAÇ-22



DTAÇ-23

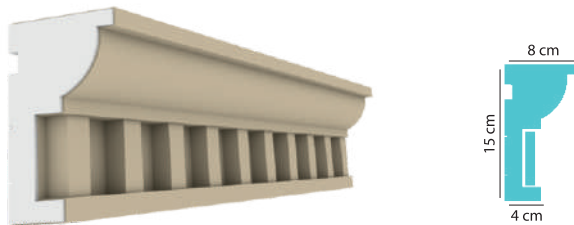

DTAÇ-24



DTAÇ-25



DTAÇ-26





DN-01

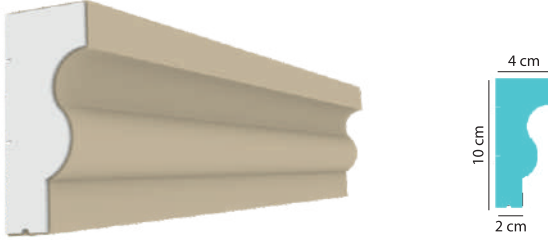

DN-02



DN-03



DN-04



DN-05

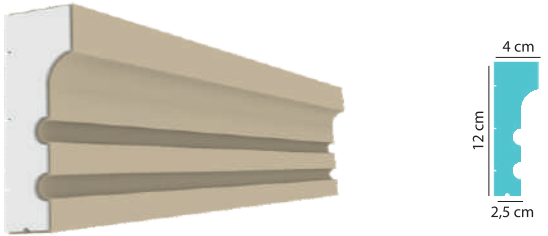

DN-06

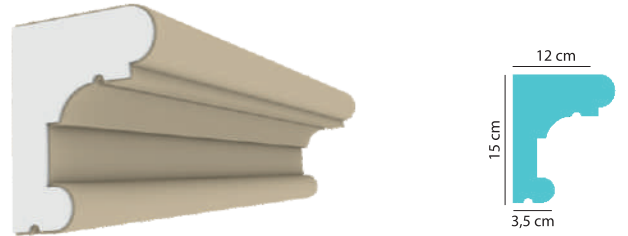

DN-07



DN-08



DN-09



DN-10



DN-11



DN-12

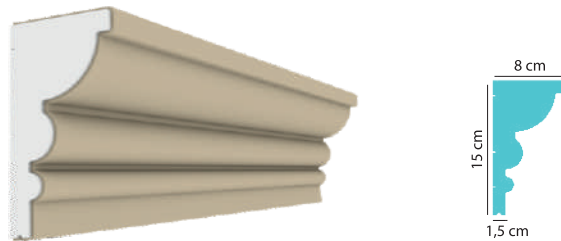

DN-13



DN-14

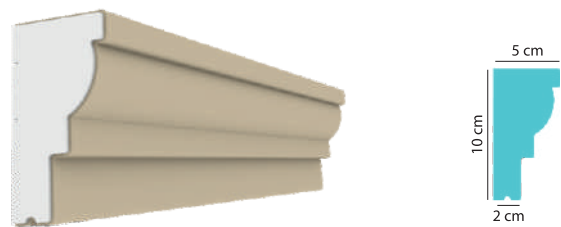

DN-15

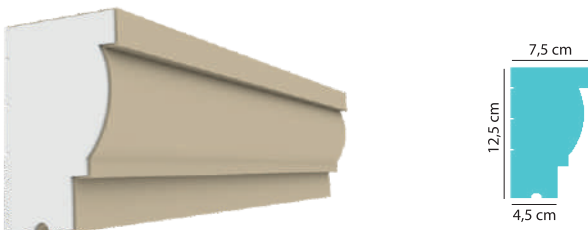

DN-16



DN-17



DN-18



DN-19



DN-20



DN-21



DN-22

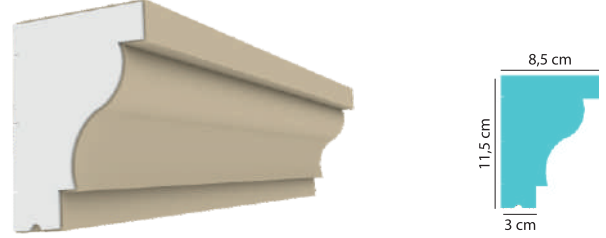

DN-23



DN-24



DN-25



DN-26

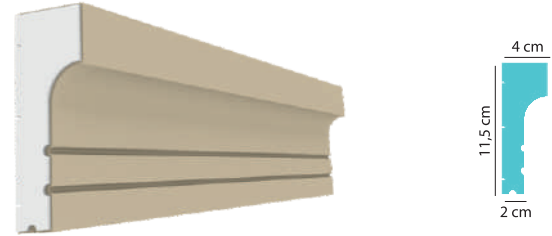

KS-01



KS-02



KS-03



KS-04



KS-05



KS-06



KS-07



KS-08



KS-09

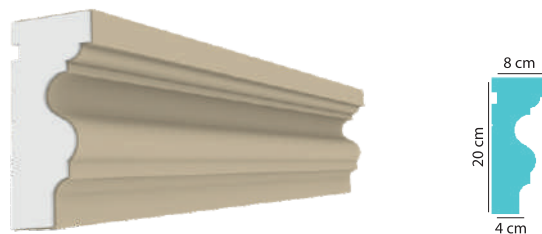

KS-10





**KS-11**

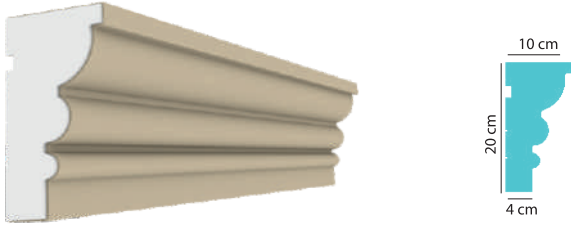

**KS-12**



**KS-13**



**KS-14**



**KS-15**



**KS-16**



**KS-17**

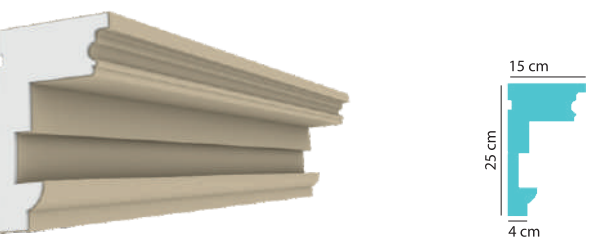

**KS-18**



**KS-19**



**KS-20**



KS-21



KS-22

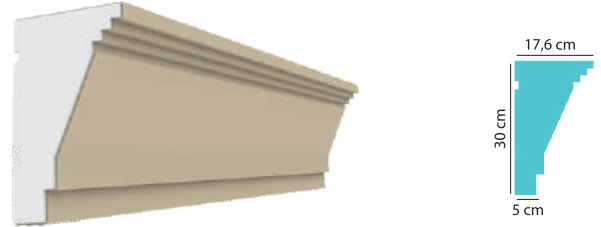

KS-23



KS-24



KS-25



KS-26



KS-27



KS-28

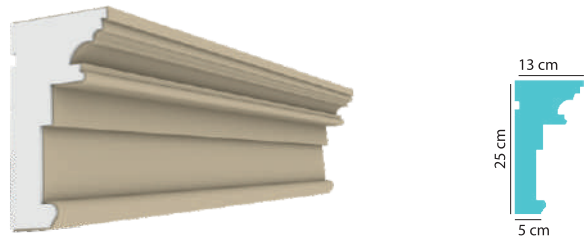

KS-29



KS-30



DKS-01



DKS-02



DKS-03



DKS-04

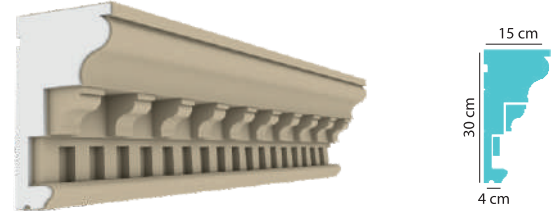

DKS-05



DKS-06



DKS-07



DKS-08

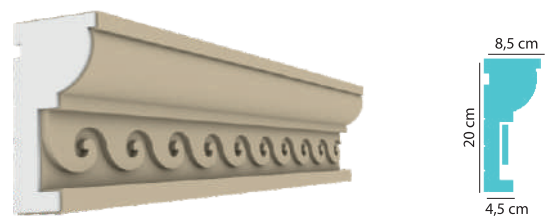

DKS-09

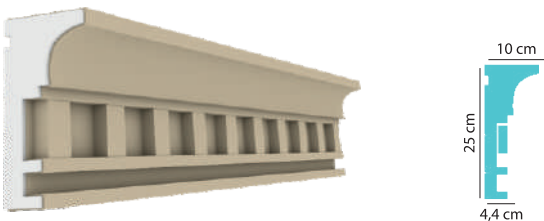

DKS-10

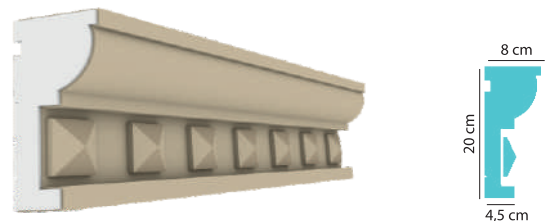

DKS-11

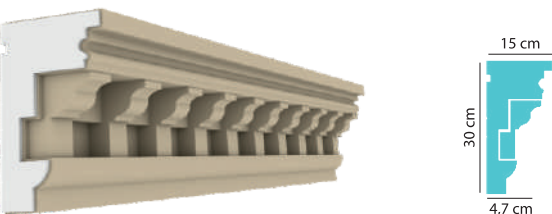

DKS-12

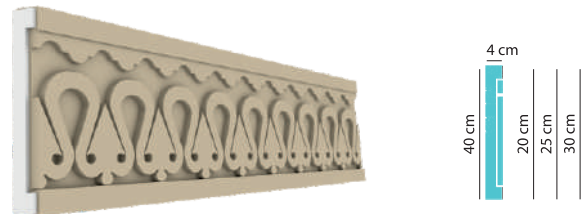

**DKP-01**

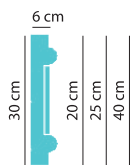
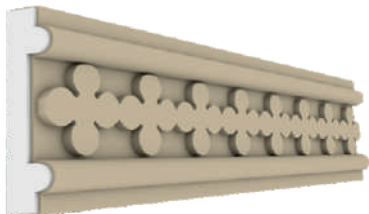

**DKP-02**

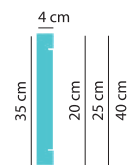

**DKP-03**

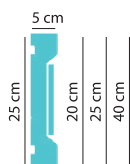

**DKP-04**

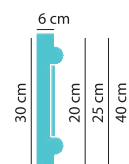

**DKP-05**

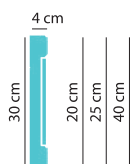

**DKP-06**

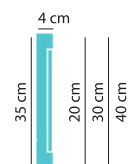
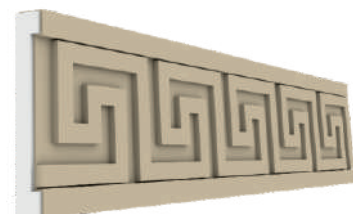

**DKP-07**

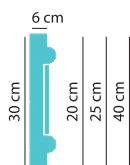

**DKP-08**

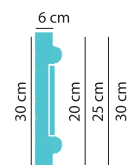

**DKP-09**

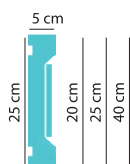

**DKP-10**

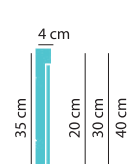
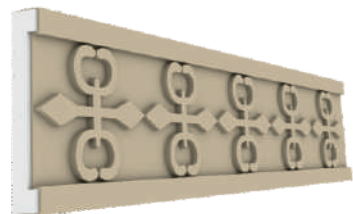

DKP-11

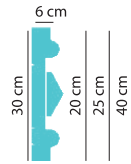

DKP-12

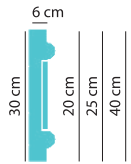

DKP-13



DKP-14

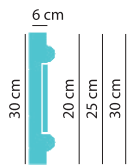

DKP-15

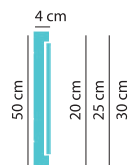

DKP-16

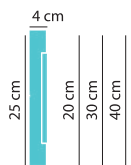

DKP-17

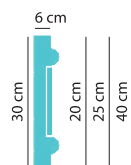

DKP-18

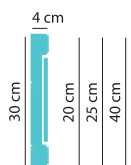
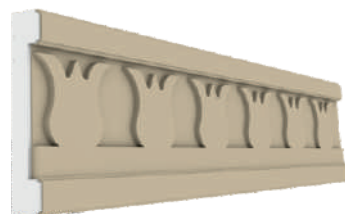

DKP-19

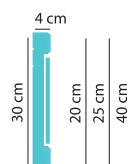
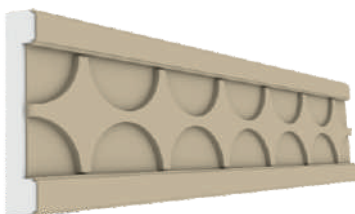

DKP-20

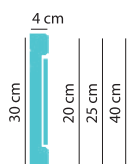



DK-01

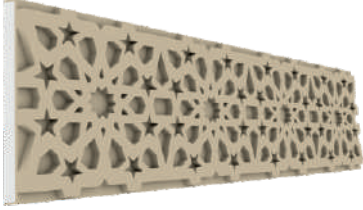

5x50x200 cm

DK-02



5x50x200 cm

DK-03



5x50x200 cm

DK-04



5x50x200 cm

DK-05



5x50x200 cm

DK-06



5x50x200 cm

DK-07

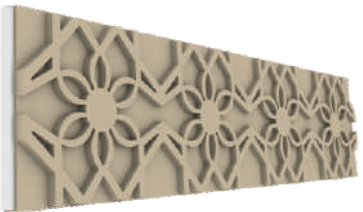

5x50x200 cm

DK-08



4x50x120 cm

DK-09

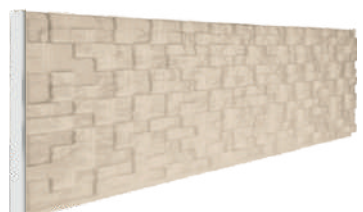

4x50x120 cm

DK-10



4x50x120 cm

DK-11



4x50x120 cm

DK-12



4x50x130 cm

DK-13



4x50x130 cm

DK-14



5x50x130 cm



TD-01



TD-02

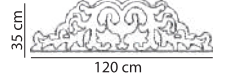

TD-03

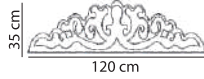

TD-04

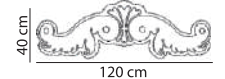

TD-05

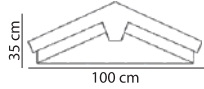

TD-06



TD-07

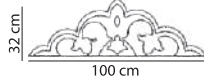

TD-08



TD-09



TD-10

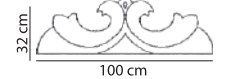

TD-11

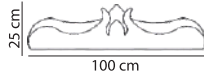

TD-12



6x60x200 cm

KE-01

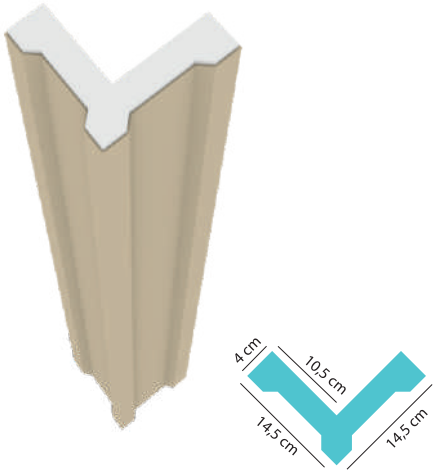

KE-02

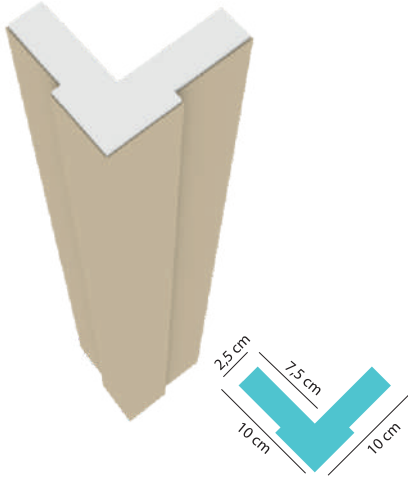

KE-03

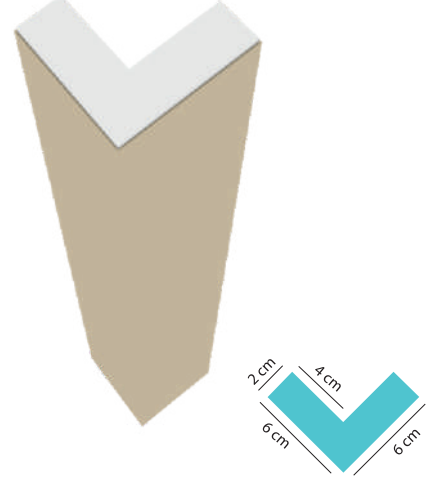

KE-04

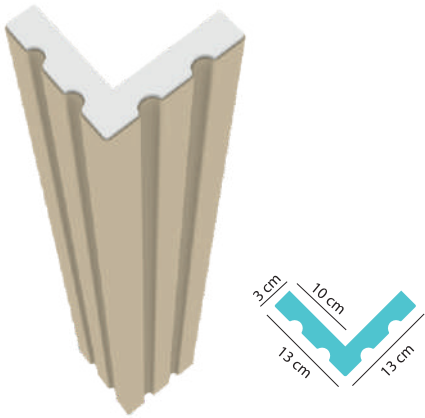

KE-05

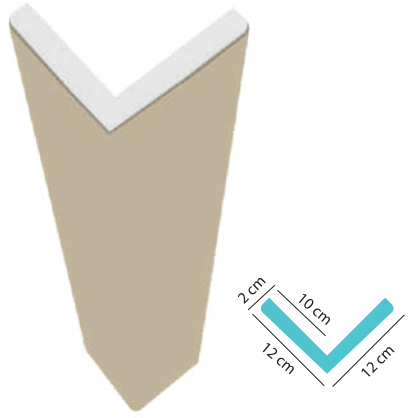

KE-06

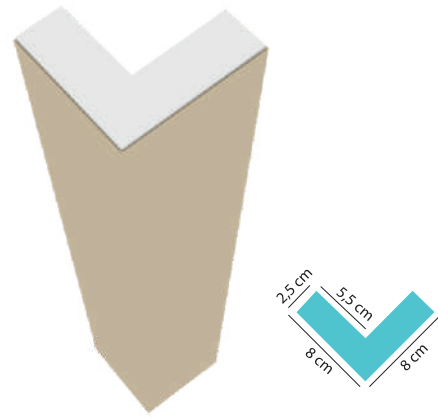

KE-07

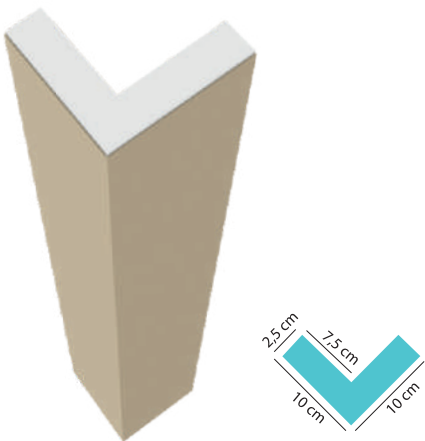

KE-08

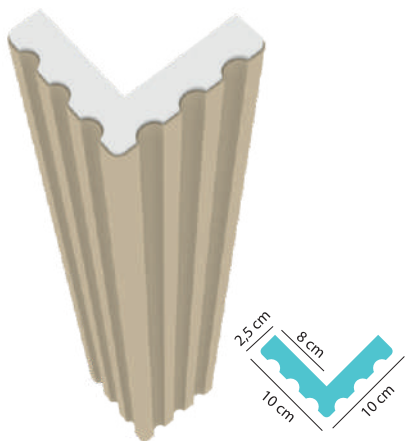

KE-09

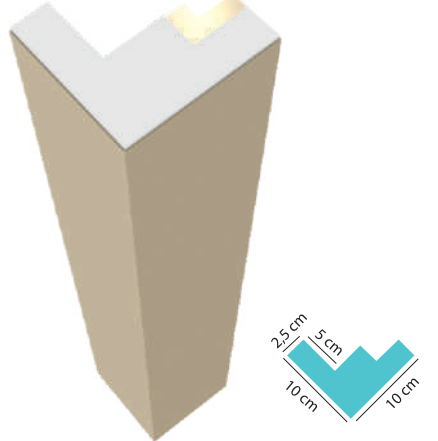



# KÖŞE ELEMANI | CORNER ELEMENT

غطاء الزوايه

KE-10

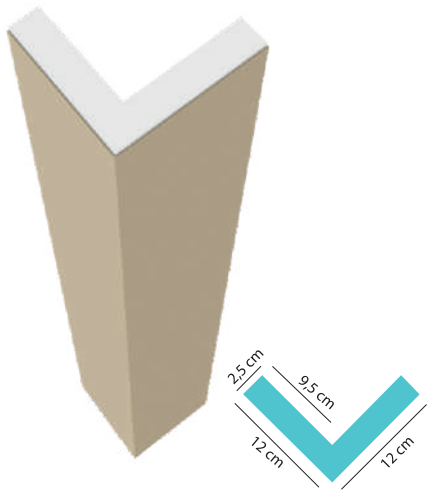

KE-11

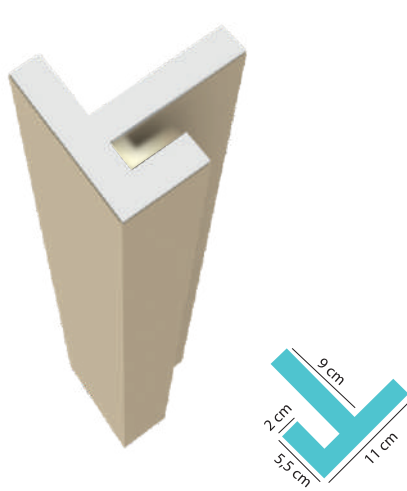

KE-12

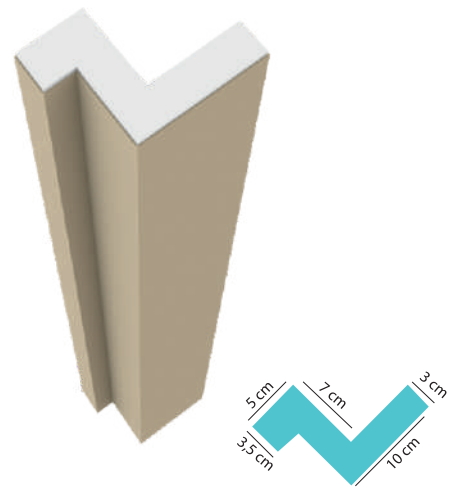

KE-13

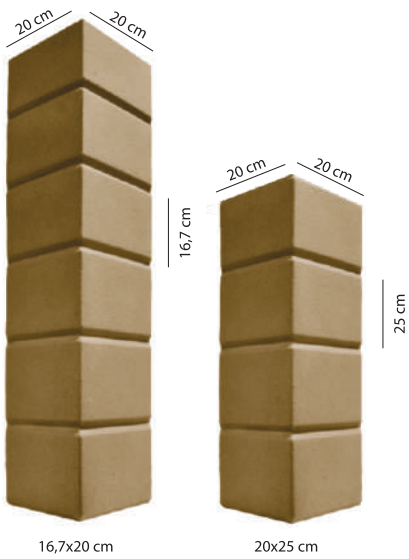

KE-14

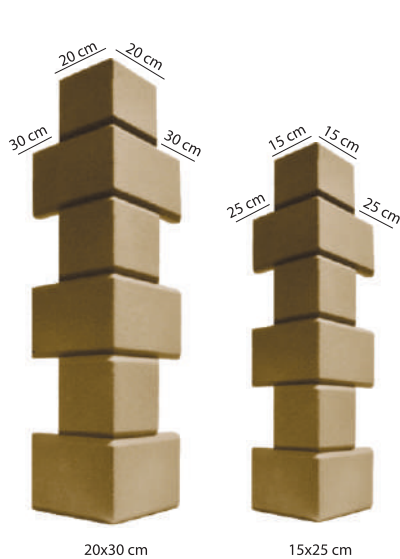

KE-15

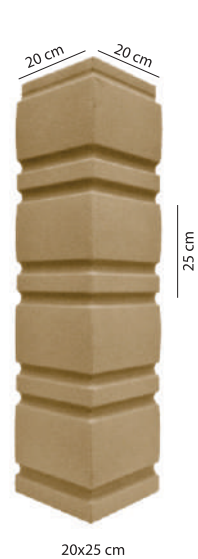



ÇT-01

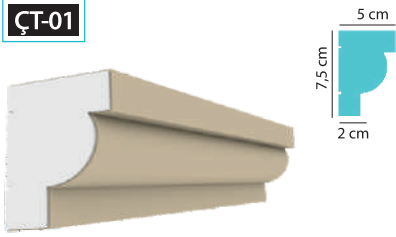

ÇT-02

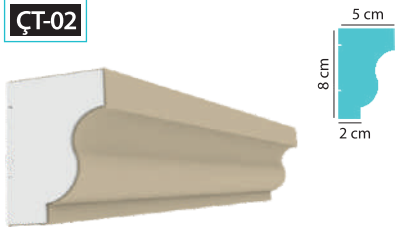

ÇT-03

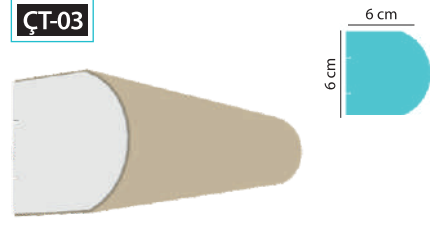

ÇT-04

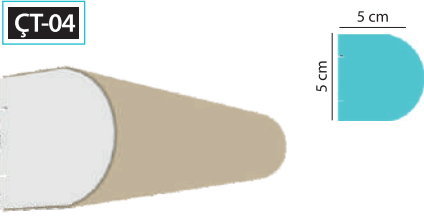

ÇT-05

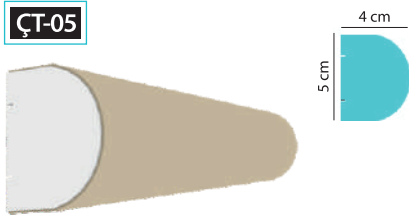

ÇT-06

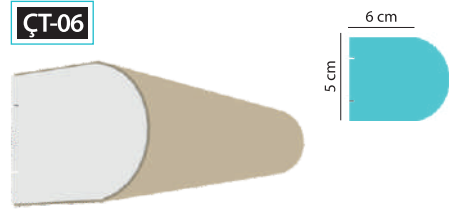

ÇT-07

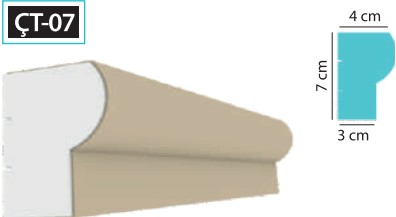

ÇT-08



ÇT-09

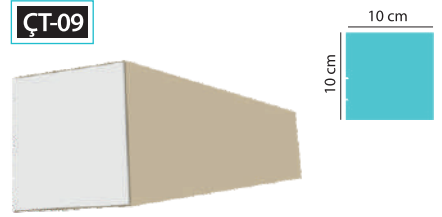

ÇT-10

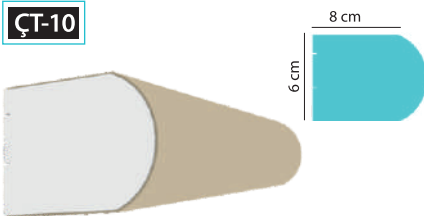

ÇT-11

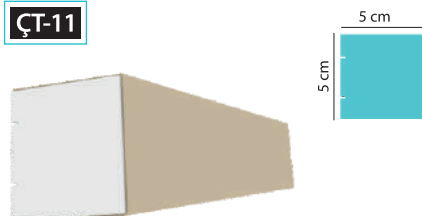

ÇT-12



ÇT-13



ÇT-14



ÇT-15

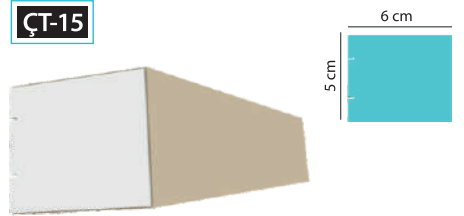

ÇT-16

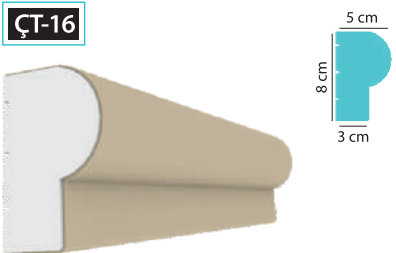

ÇT-17

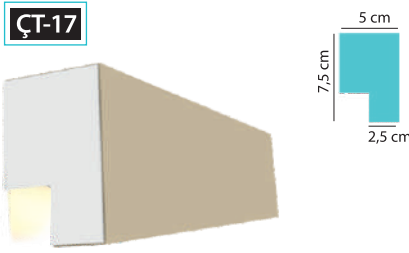

ÇT-18

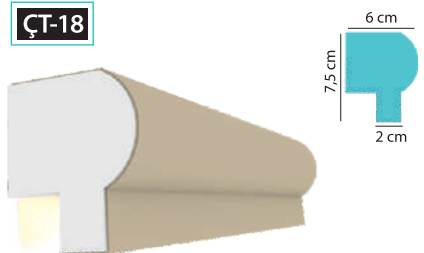

DS-01

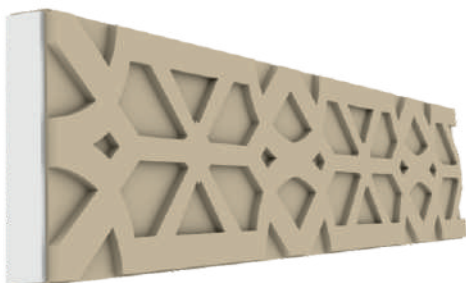

5x50x200 cm

DS-02



5x50x200 cm

DS-03

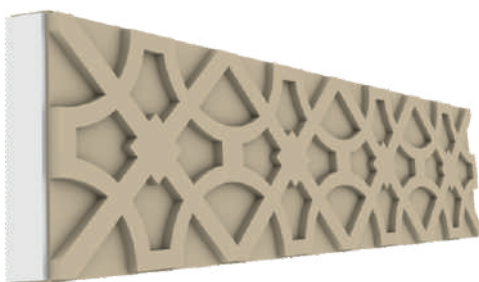

5x50x200 cm

DS-04

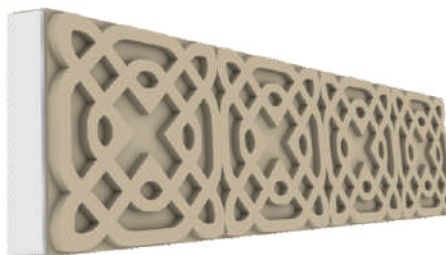

5x50x200 cm

DS-05

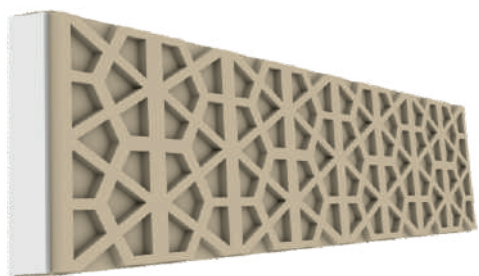

5x50x200 cm

DS-06



3x50x50 cm

DS-07



3x50x50 cm



DS-09



3x50x150 cm

DS-10

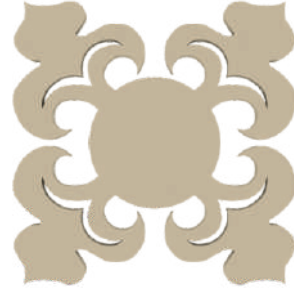

3x50x50 cm

DS-11



3x50x150 cm

DS-12

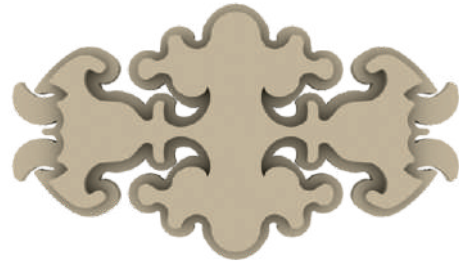

3x30x50 cm

DS-13



3x50x150 cm

DS-14



3x50x150 cm

DS-15



5x30x70 cm

DS-16



5x30x70 cm

ST-01

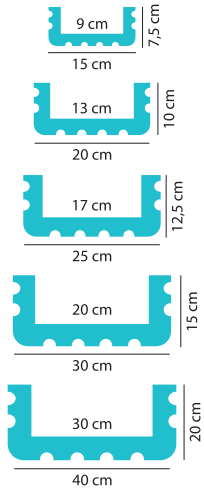
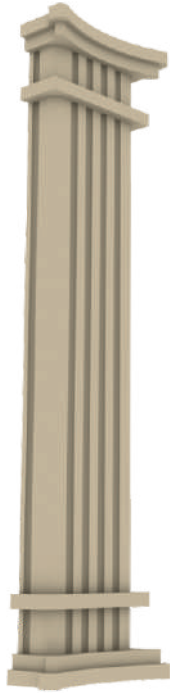

ST-02

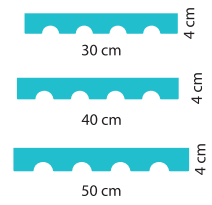
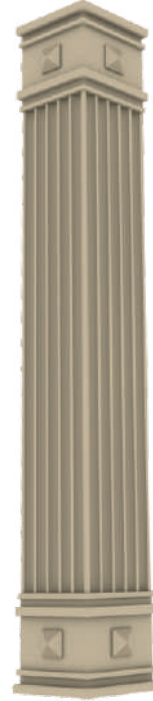

ST-03

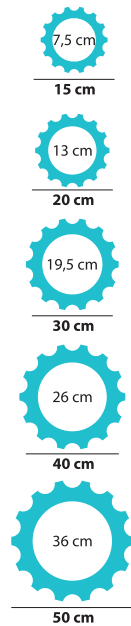
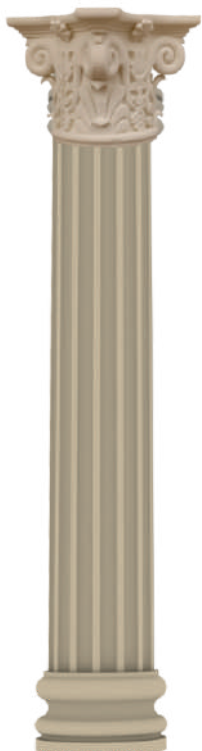

ST-04

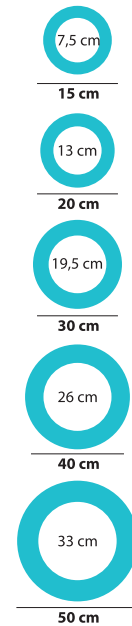

STK-01

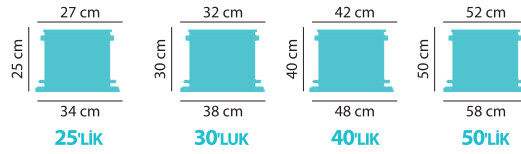

STK-02

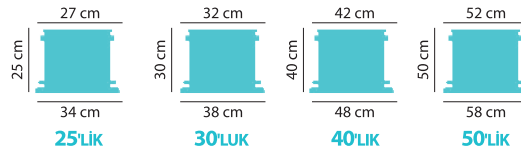

STK-03

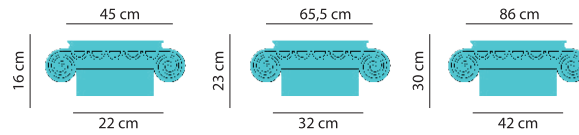

STK-04

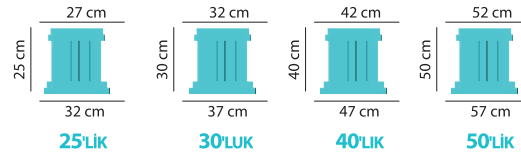

STK-05

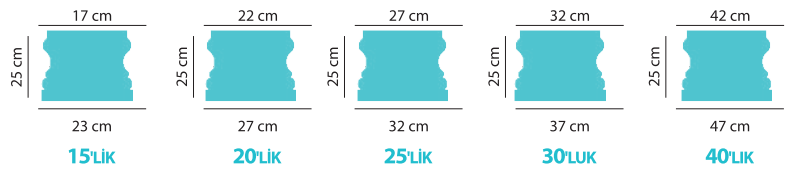

STK-06

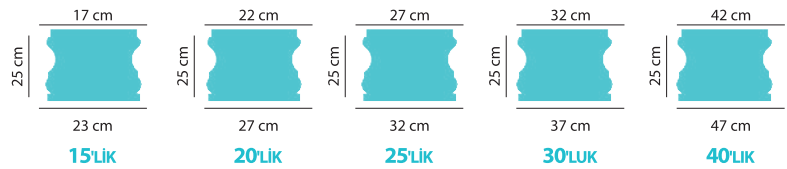

STK-07

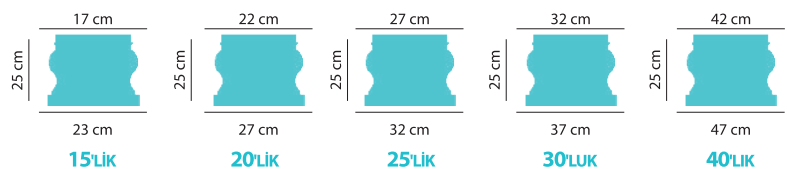



STK-08

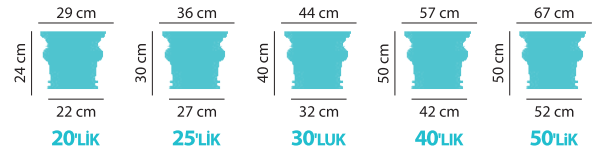

STK-09

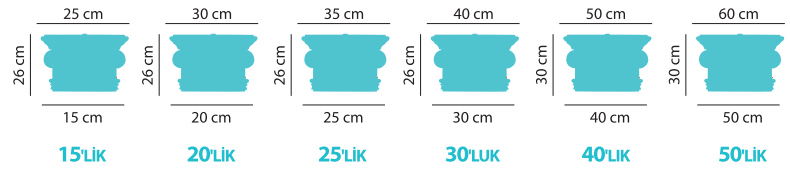

STK-10

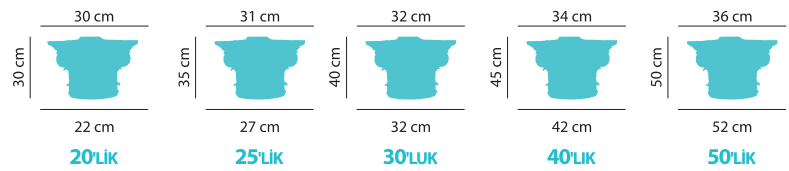

STK-11

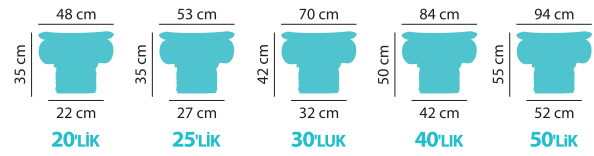

**BK-01**

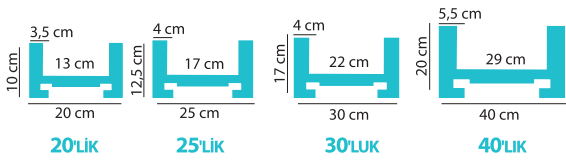
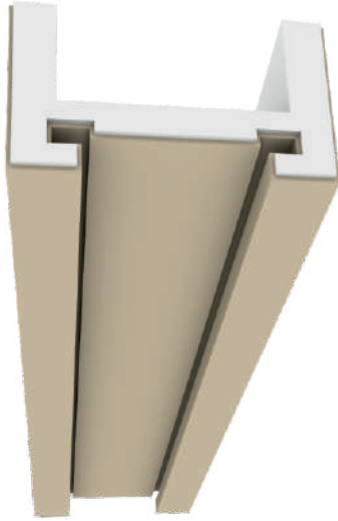

**BK-02**

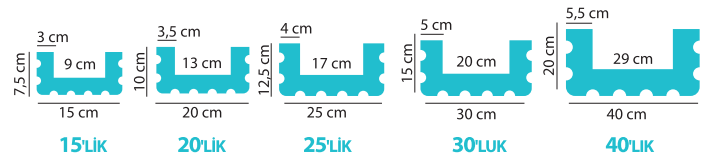

**BK-03**

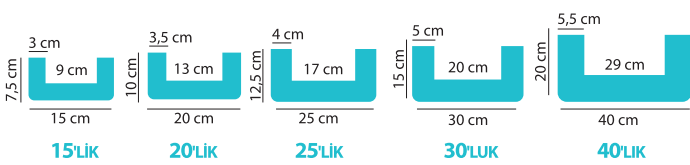
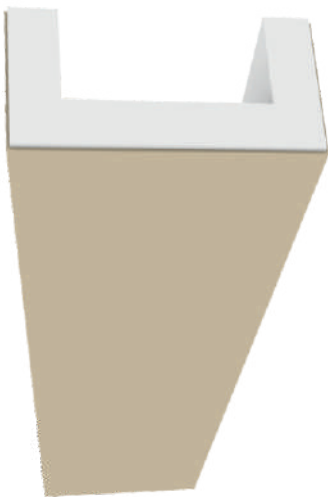

**BK-04**

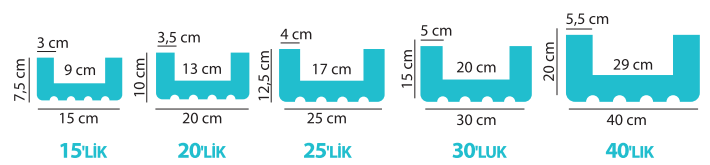
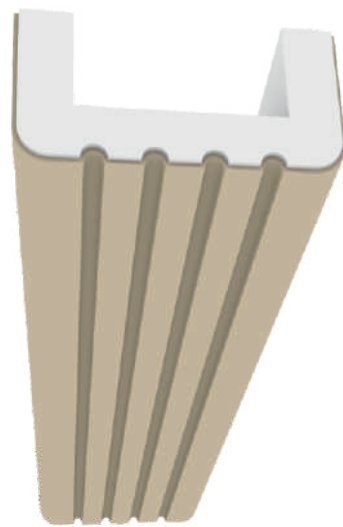

PY-01

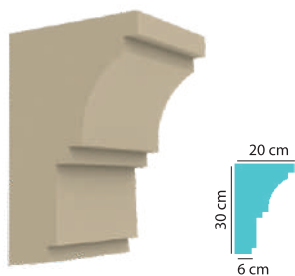

PY-02

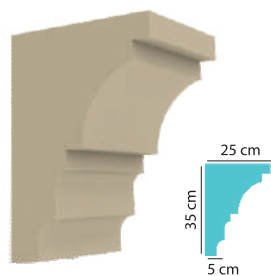

PY-03

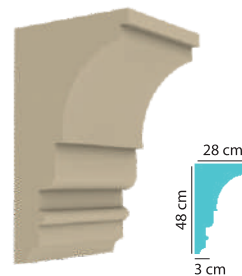

PY-04

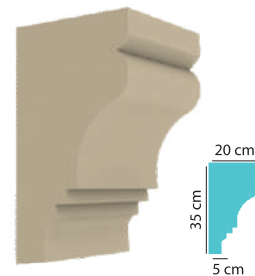

PY-05

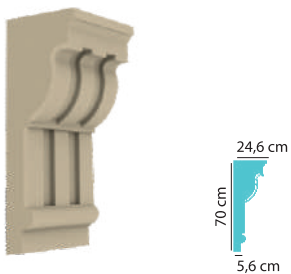

PY-06

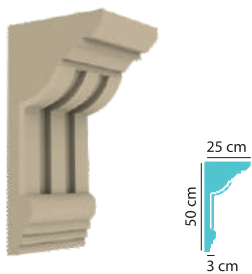

PY-07

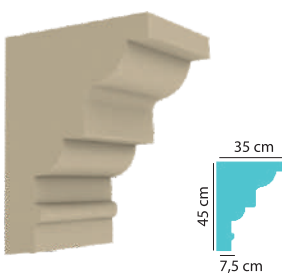

PY-08

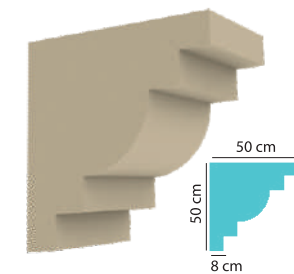

PY-09

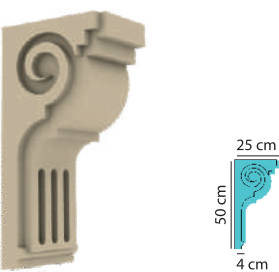

PY-10

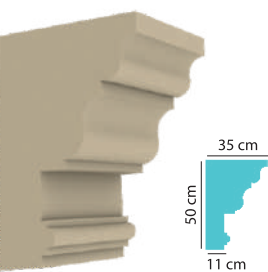

PY-11

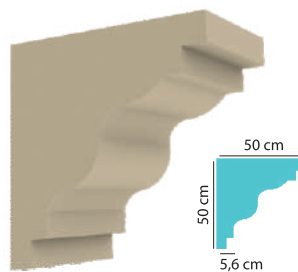

PY-12

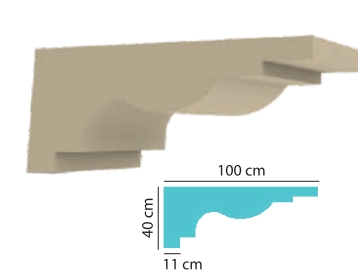

PY-13

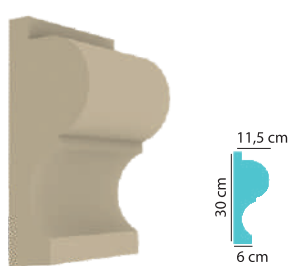

PY-14

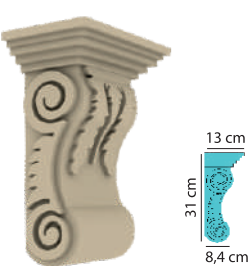

PY-15

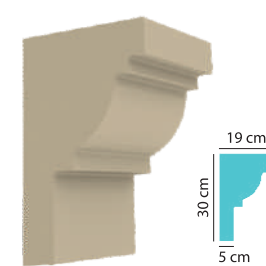

PY-16

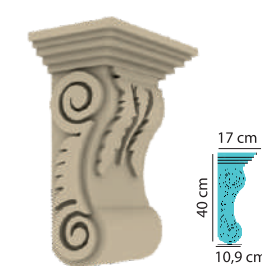

PY-17

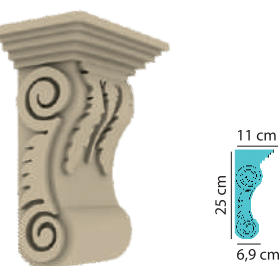

PY-18

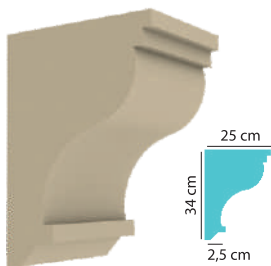

PY-19

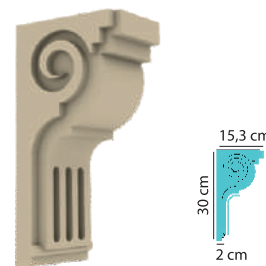

PY-20

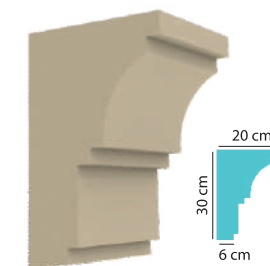

KT-01

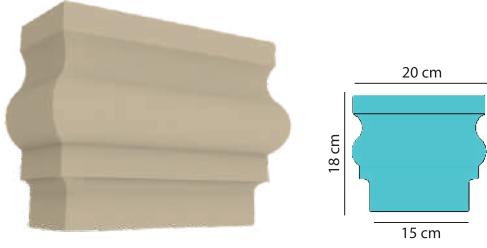

KT-02



KT-03

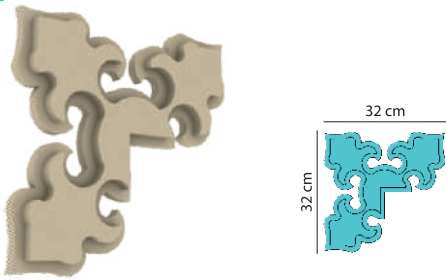

KT-04

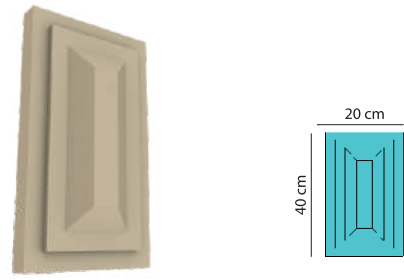

KT-05

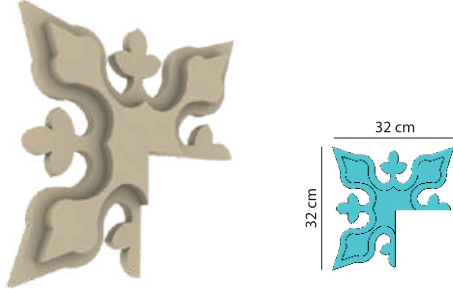

KT-06

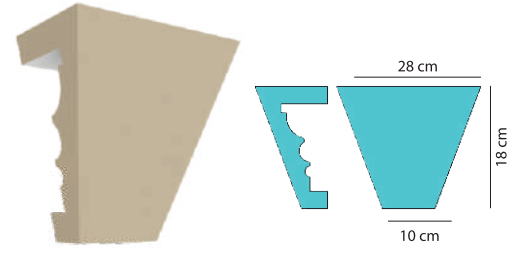

KT-07

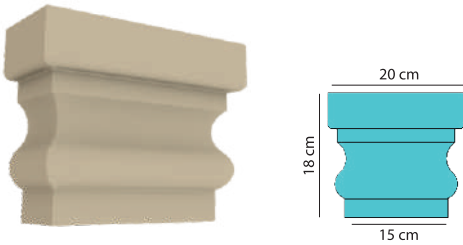

KT-08

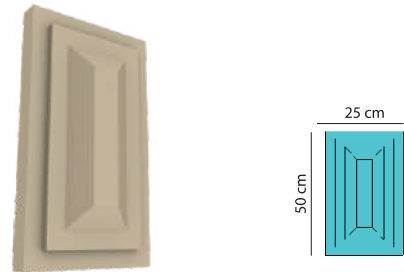

KT-09

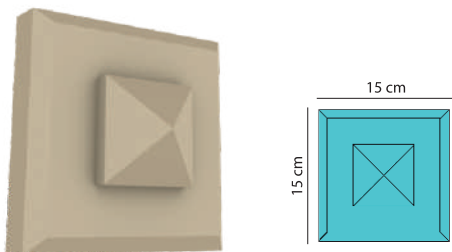

KT-10

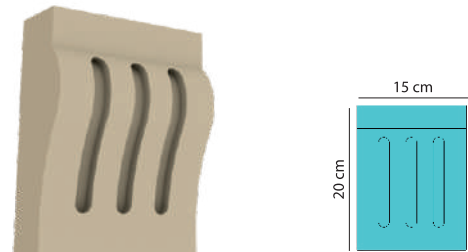



HRP-01

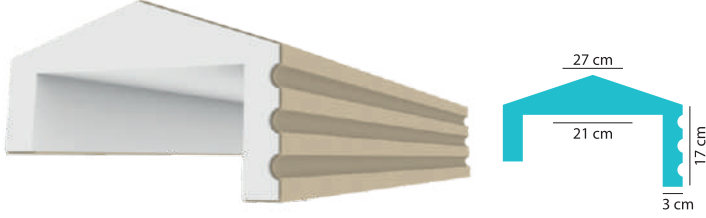

HRP-02

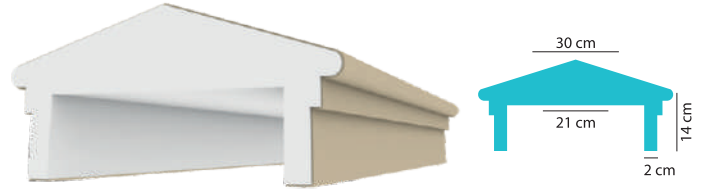

HRP-03

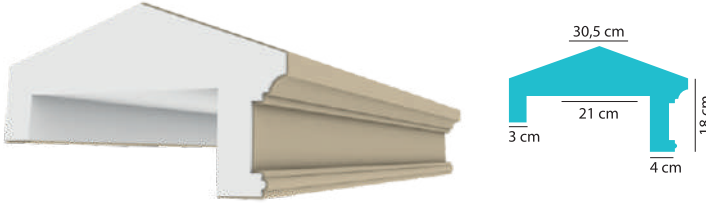

HRP-04

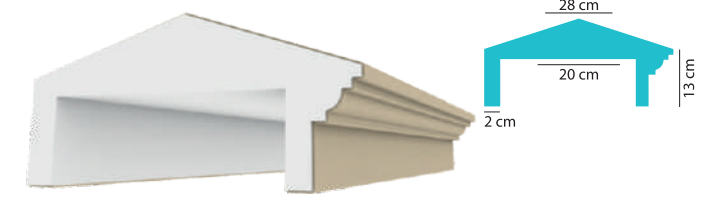

## ÇEMBER | CIRCLE | دائرة

CMB-01

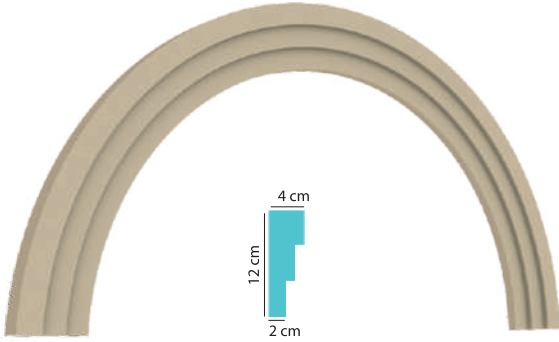

CMB-02

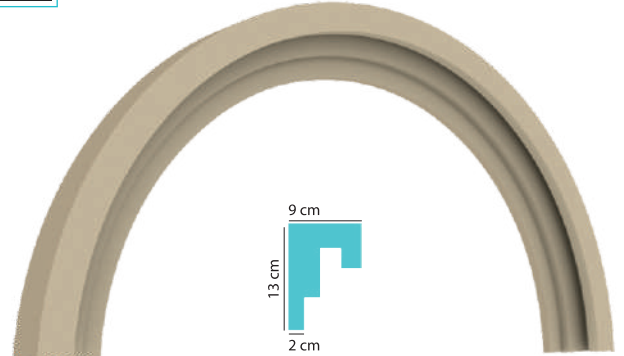



GIP-01

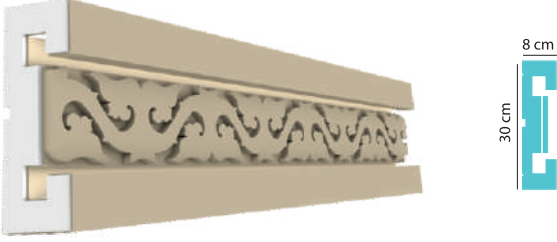

GIP-02

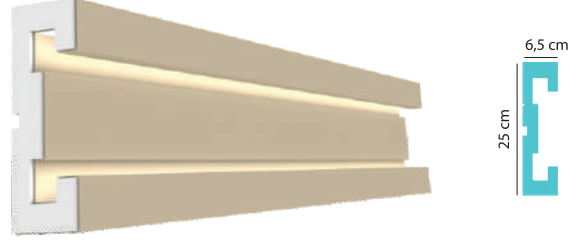

GIP-03

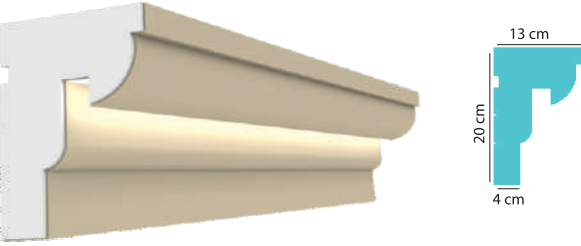

GIP-04

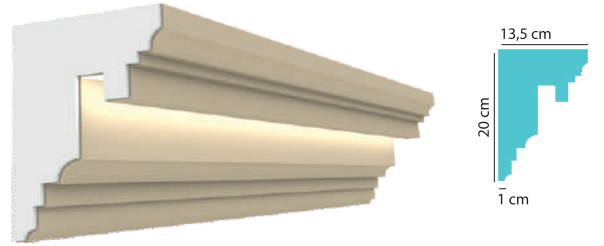

GIP-05

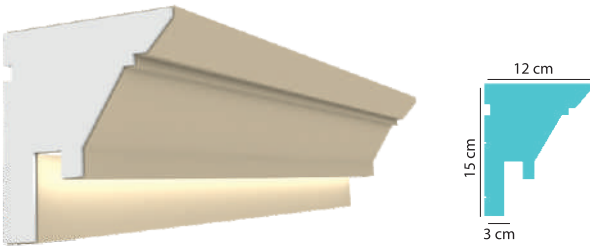

GIP-06



GIP-07

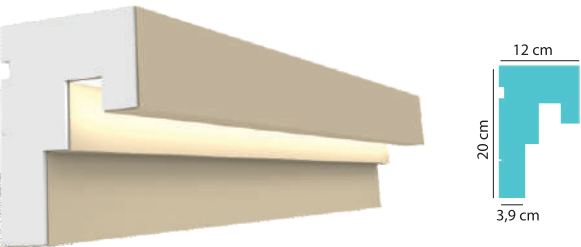

GIP-08

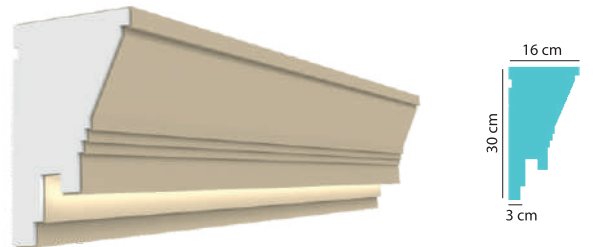

GIP-09

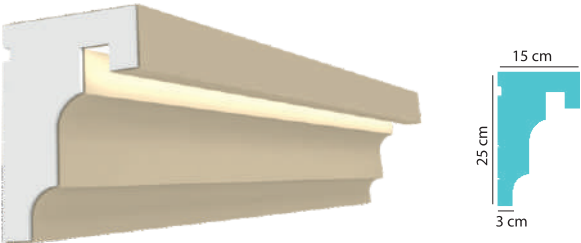

GIP-10



# GİZLİ IŞIK PROFİLLERİ | HIDDEN LIGHT PROFILES

لمحات ضوء خفية

GIP-11



GIP-12



GIP-13



GIP-14

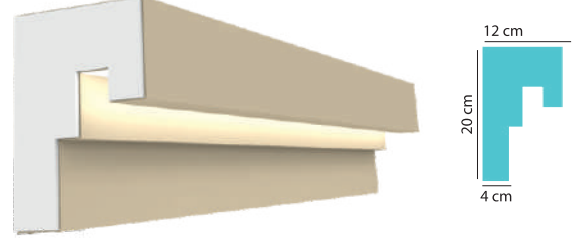

GIP-15

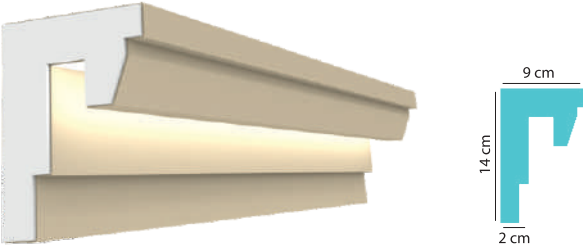

GIP-16



GIP-17

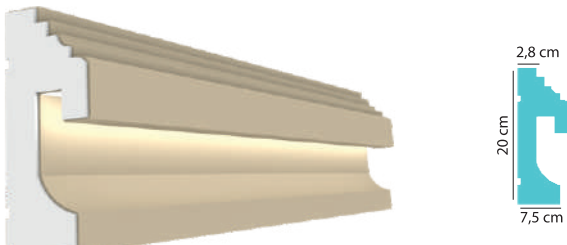

GIP-18

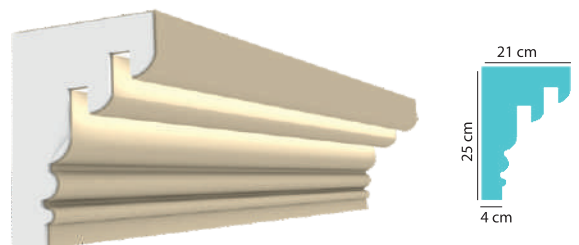

GIP-19



GIP-20

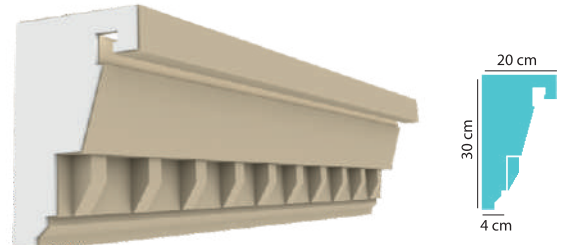

FG-01

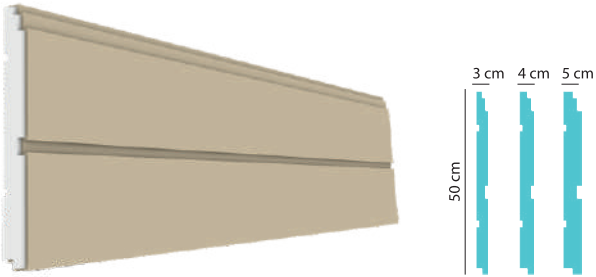

FG-02

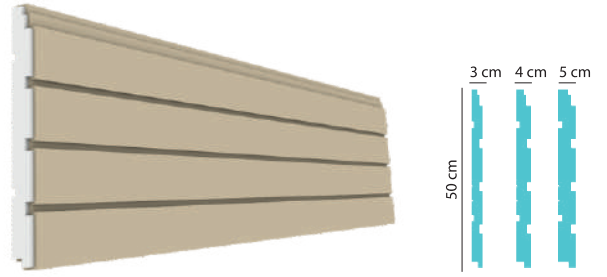

FG-03



FG-04



FG-05

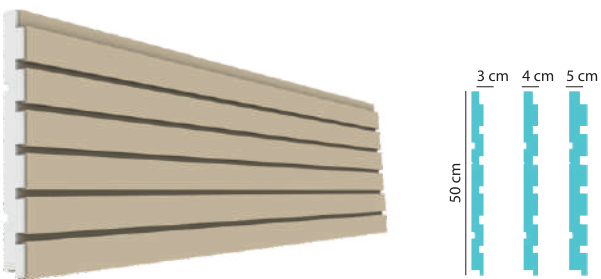

FG-06

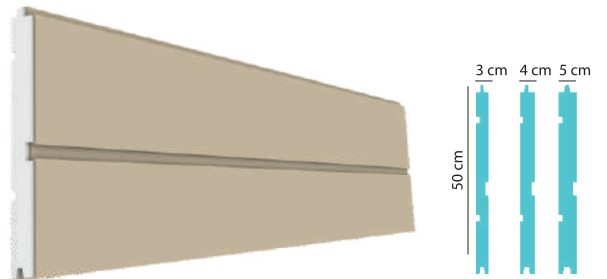

FG-07



FG-08



YB-01



YB-02

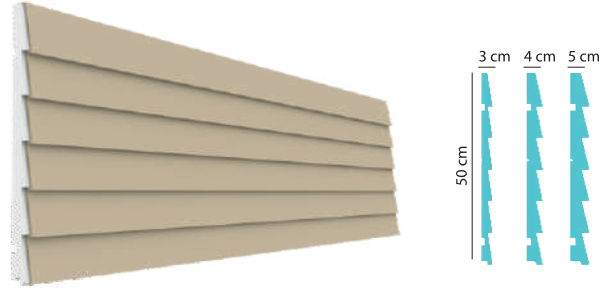

YB-03

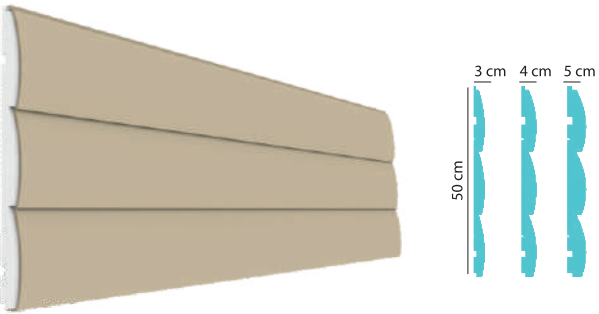

YB-04





**EPS-01** D1 500 g Dondurma Kutusu



İç: 12,5x22,9x8,5 cm  
Dış: 16,5x27x12,5 cm

**EPS-04** B1 5 kg Delikli / Deliksiz Kutu



İç: 26,7x36,2x13,5 cm  
Dış: 29,5x39x16,5 cm

**EPS-02** D2 1000 g Dondurma Kutusu



İç: 12,5x22,9x11,5 cm  
Dış: 16,5x27x16 cm

**EPS-05** B3 15 kg Deliksiz Kutu



İç: 33,5x45,5x21 cm  
Dış: 40x50x25 cm

**EPS-03** D3 1500 g Dondurma Kutusu



İç: 16,5x22,5x12 cm  
Dış: 20,5x26,5x18,6 cm

**EPS-06** K1 20 kg Deliksiz Kutu



İç: 37x51x24,3 cm  
Dış: 42,5x56x30 cm



EN İYİ DESENLERİ KARTONPIYER BANYO KARTONPIYERİ BORDÜR BİTİŞ PROFİLİ İŞIK BANDI DEKOR  
ÇITA • PERDE TAKVIYESİ • LAMBA GÖBEKLERİ • ASMA TAVAN • TAVAN KAPLAMA • FUGA • DESENLİ FU  
I • TUĞLA GÖRÜNÜMLÜ KAPLAMA • SÖVE • DENİZLİK • TAÇ - TAÇ DEKOR ÜRÜNLERİ • KAT SİLMESİ •  
MA PROFİLLERİ • BORU KAPLAMA PROFİLLERİ • KÖŞE ELEMANLARI • ENJEKSİYON KÖŞE ELEMANL  
PAYANDA • KİLİTTAŞI • BALKON SÜSÜ • PENCERE ALT DEKOR • SÜTUN KAİDE • YUVARLAK PENCERE MO  
ER • EPS DESENLİ KARTONPIYER • BANYO KARTONPIYERİ • BORDÜR • BİTİŞ PROFİLİ • İŞIK BANDI • DEKOR  
ITA • PERDE TAKVIYESİ • LAMBA GÖBEKLERİ • ASMA TAVAN • TAVAN KAPLAMA • FUGA • DESENLİ FU  
TUĞLA GÖRÜNÜMLÜ KAPLAMA • SÖVE • DENİZLİK • TAÇ - TAÇ DEKOR ÜRÜNLERİ • KAT SİLMESİ • C  
IA PROFİLLERİ • BORU KAPLAMA PROFİLLERİ • KÖŞE ELEMANLARI • ENJEKSİYON KÖŞE ELEMANLA  
PAYANDA • KİLİTTAŞI • BALKON SÜSÜ • PENCERE ALT DEKOR • SÜTUN KAİDE • YUVARLAK PENCERE K



# İÇ CEPHE ÜRÜNLER

## *interior products*

منتجات الديكور الداخليه







**DG-01**

Düz

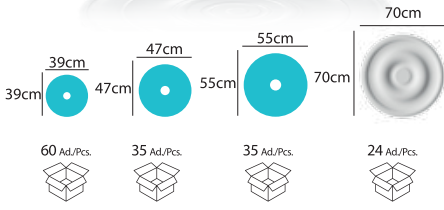

**DG-02**

Papatya

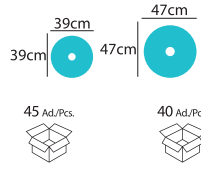

**DG-03**

Baklava

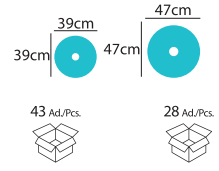

**DG-04**

Başak

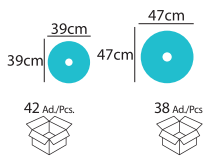

**DG-05**

At Kuyruğu

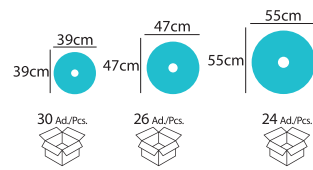

**DG-06**

Altıgen

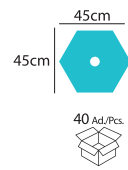

**TK-01**

Ufuk Çizgisi

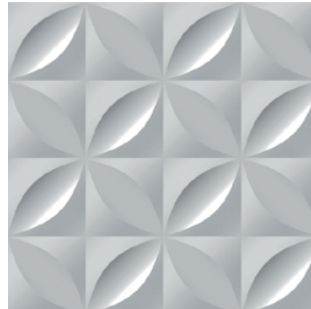
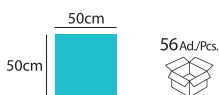

**TK-02**

Arzum

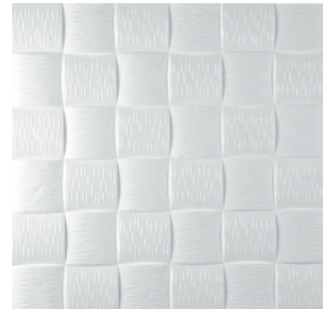
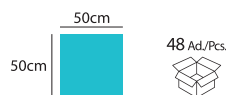

**DG-06**

Hasır

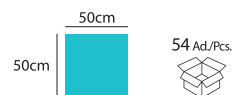

**D-01**

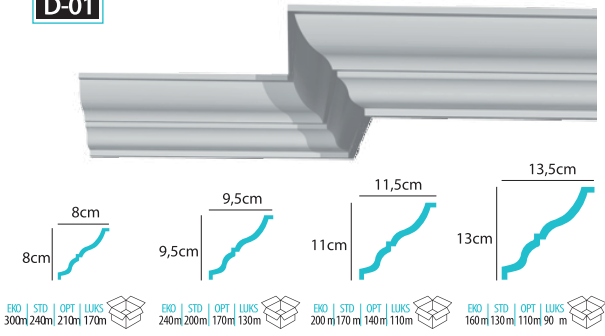

**D-02**

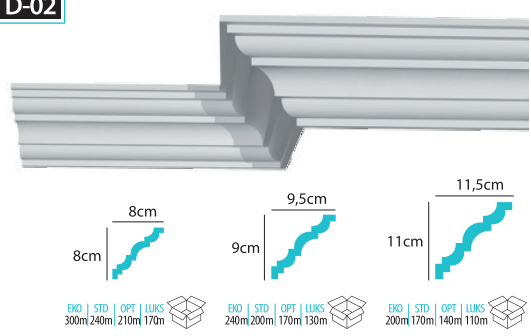

**D-03**

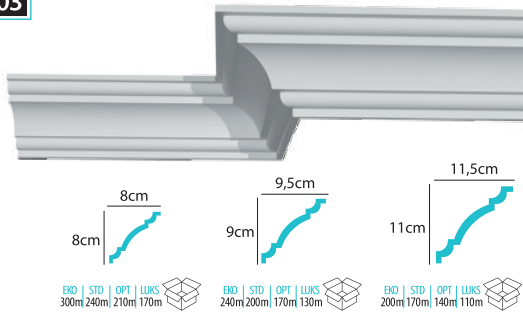

**D-04**

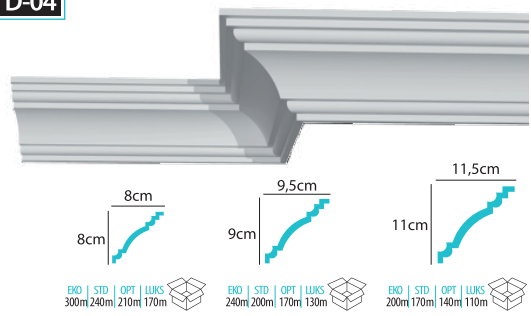

**D-05**

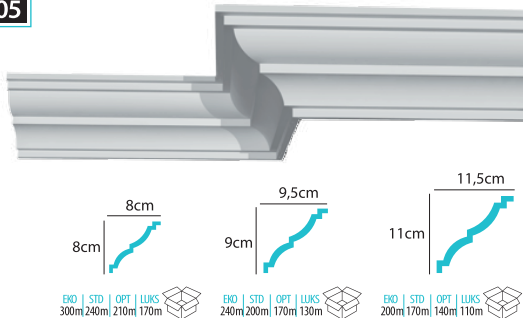

**D-06**

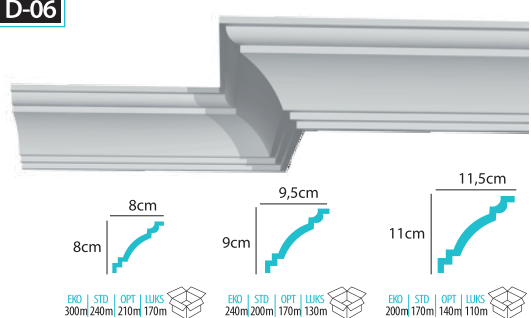

**D-07**

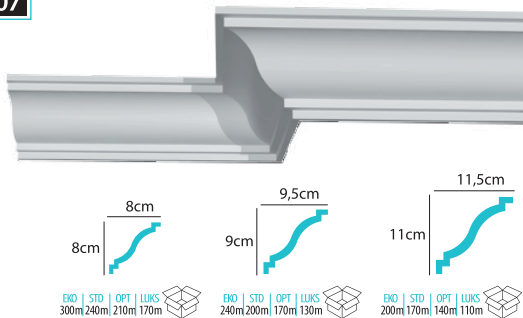

**D-08**

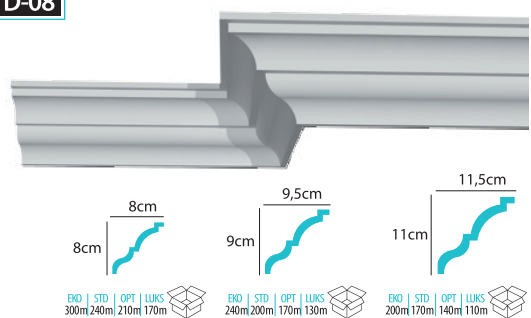

**D-09**

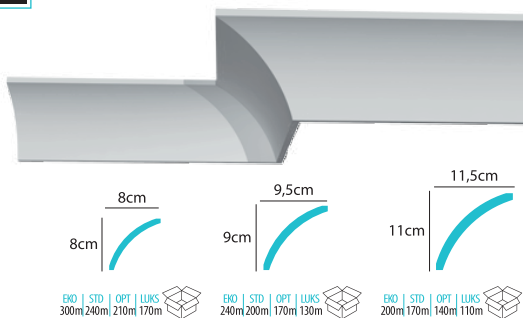

**D-10**

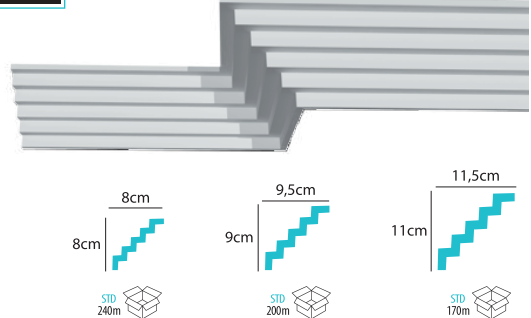

**D-11**

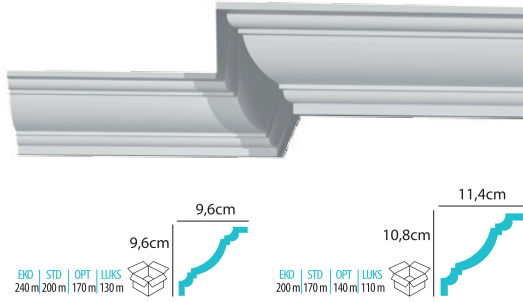

**D-12**

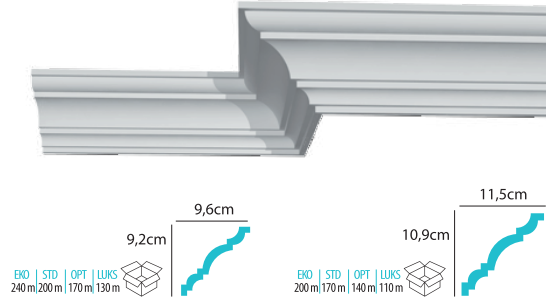

**D-13**

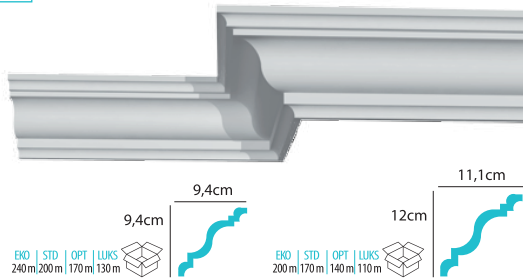

**D-14**

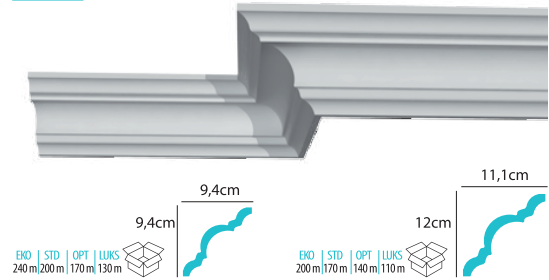

**D-15**

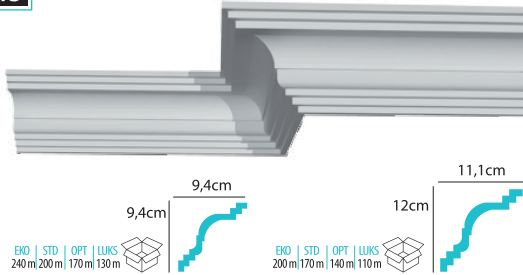

**D-16**

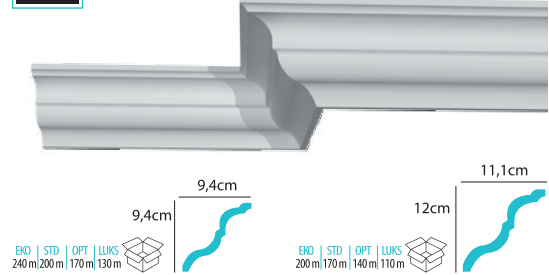

**D-17**

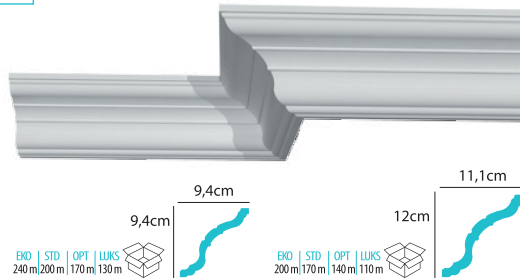



# PERDE TAKVIYELERİ | CURTAIN REINFORCEMENTS

دعمات الستائر



ÇT-01 Çıta

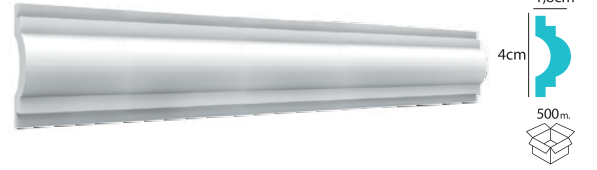

ÇT-02 Çıta



XPS PT-08

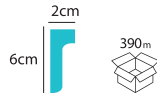

XPS PT-10

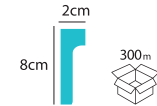

XPS PT-12

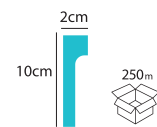

XPS PT-İŞİK

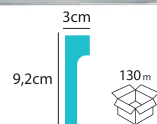

EÇK-01  
Çıta Köşesi  
300 Ad./Pcs.





## EPS ASMOLENİN YARARLARI

- \* TS 7316 EN 13163 ve TS 825 normlarına uygundur.
- \* Katlar arası ısı ve darbe ses yalıtımını sağlar.
- \* Uygulanan yapılarda binaya yük olmaz, demir ve beton tasarrufu sağlar. Bina maliyetini azaltır.
- \* Tasıma işçiligini %80 azaltır.
- \* Sıfır fire ile yerine uygulanır.
- \* EPS POLISTREN ısı yalıtım malzemesi olması sebebiyle kat aralarındaki yalıtım ve ses geçirgenliğini azaltmaktadır.
- \* Uygulama sırasında kalıp üzerine serilen elyaf file, sıva sonrası çatlama riskini ortadan kaldırır.
- \* Bina durdukça yalıtım görevine devam etme özelliğine sahiptir.
- \* Yüksek basınç dayanımı vardır.



ÖLÇÜLER	ASMOLEN AĞIRLIĞI KG	m <sup>3</sup> deki ASMOLEN ADEDİ	DÖŞEMEYE GETİRDİĞİ YÜK (KG/m <sup>2</sup> )
20x40x100 cm Standart	0,8	12,5	2
23x40x100 cm Özel	0,92	10,9	2,3
25x40x100 cm Standart	1	10	2,5
28x40x100 cm Özel	1,12	8,9	2,8
30x40x100 cm Özel	1,2	8,3	3

## EPS ISI YALITIM | EPS INSULATION

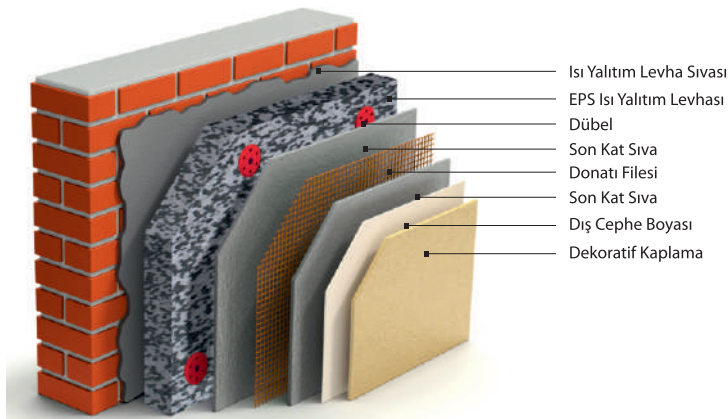

Isı Yalıtımı Yapılmamış Bina

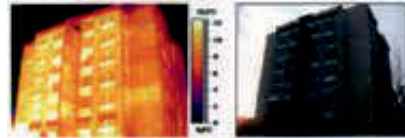

Isı Yalıtımı Yapılmış Bina

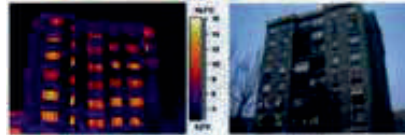

ÖLÇÜ	PAKET İÇİ ADET	PAKET İÇİ m <sup>2</sup>	PAKET İÇİ m <sup>3</sup>	1 m <sup>3</sup> KAÇ m <sup>2</sup> EDER	1 m <sup>3</sup> deki ADET
2x50x100 cm	25 Adet	12,5	0,25	50	100
3x50x100 cm	16 Adet	8	0,24	33	66
4x50x100 cm	12 Adet	6	0,24	25	50
5x50x100 cm	10 Adet	5	0,25	20	40



SÖVE DERZ TUTKALI



SÖVE KAPLAMA HARC



POLİÜRETAN TABANCASI



POLİÜRETAN SÖVE ve MANTOLAMA YAPIŞTIRICISI



ISI YALITIM LEVHASI  
m<sup>2</sup> Tüketim Miktarı: 1m<sup>2</sup>

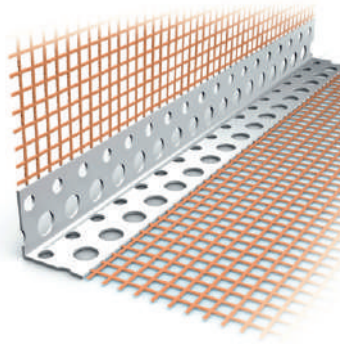

FİLELİ KÖŞE PROFİLİ  
m<sup>2</sup> Tüketim Miktarı: 0,25 mtül

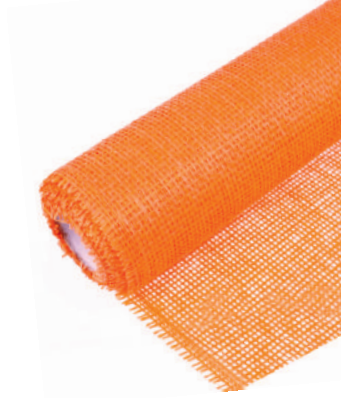

DONATI FİLESİ  
m<sup>2</sup> Tüketim Miktarı: 1,1m<sup>2</sup>



DUBEL  
m<sup>2</sup> Tüketim Miktarı: 6 Adet



ISI YALITIM LEVHASI  
SIVA HARC



DEKORATİF SIVASI



FLEX DERZ DOLGUSU



ISI YALITIM LEVHASI  
YAPIŞTIRMA HARC









# GİZLİ IŞIK PROFİLLERİ

HIDDEN LIGHT PROFILES

لمحات ضوء خفية

**GENC**<sup>®</sup>  
DEKORATİF ISI YALITIM







**PAK YALITIM**

DECORATIVE HEAT INSULATION

العزل الحراري الزخرفية الخارجي

GENÇSÖVE ISI YALITIM İNŞ. YAPI  
ELEMENLARI SAN. VE TİC. LTD. ŞTİ.

Yakapınar Mah. İpekyolu Cad. Çukobirlik  
Binası No: 3/2 Yüreğir / ADANA / TÜRKİYE

T. +90 534 631 91 15

T. +90 538 319 58 59

info@gencyalitim.com.tr

www.gencyalitim.com.tr